

REPORT OF THE 326th CELL EXCHANGE

JUNE 6, 2007

B-Cell Line	391-392
Serum	925-928
DNA Extract	389-392
Cells	1301-1304

B-cell line Exchange

We wish to acknowledge the collaboration of **Eric Mickelson and John Hansen, Fred Hutchinson Cancer Research Center, Seattle**, for providing workshop cells, and **Fu-Meei Robbins, National Institutes of Health, Bethesda**, for offering unusual cells to type in the Cell Exchange.

TER-391. This cell was typed in the previous workshops as IHW#9381, as correctly identified by Ball and J.Lee. Ball and Chen were astute in noting that this cell, TER317, serves as a reference for the rare DRB1*0315. It was previously typed as TER-317 in 2003, as commented by a number of labs (Ball, Chen, Cook, J.Lee, Lefor, Mah, Stamm, Tiercy).

In this retyping, DRB1*0315 was detected by 65%, comparable to the 2003 percent detection level of 70%. There is only one difference in exon 2 (pos 317, A→C) between DRB1*030101 and DRB1*0315, which may account for DRB1*0301 being misassigned by 5%.

A short DR3 (70%) was defined by serology, with assignments of DR17 (20%) and DR18 (10%). Dunn observed that the reactivity of this cell was negative to DR3 antisera, but positive to anti-DR13 and some -DR14 sera. Hahn commented that it reacted more as DR13 or DR14 than DR3, in agreement with the comments by Cook in the initial 2003 typing.

DRB1*0407 (74%) and DR4 (100%) were well typed.

DRB1* 0315-DRB3*0202-DQB1*0201-DQA1*0501 and DRB1*0407-DRB4*0103-DQB1*0302-DQA1*0301 were the probable haplotypes.

Darke reported DPA1*0103/07/09/05, -.

DPB1*0202 and DPB1*0402 were reaffirmed in this present retyping.

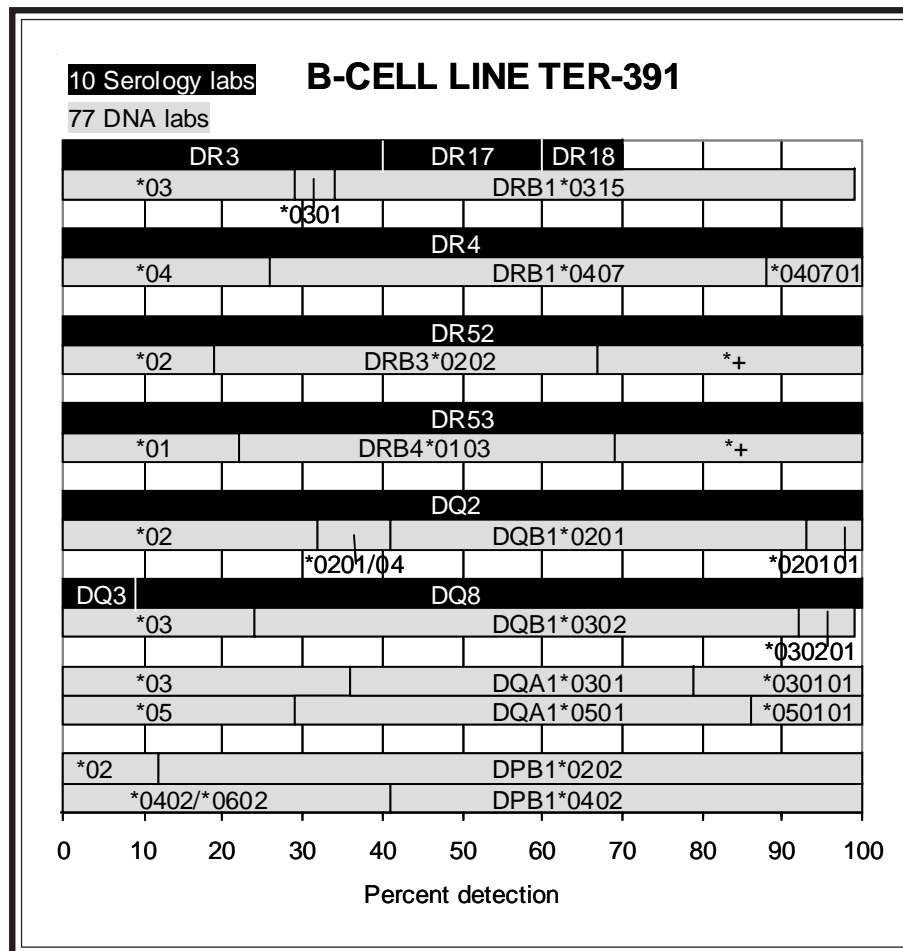

TER-392. This cell from a Caucasian donor was well typed as DRB1*0101, DRB1*0301, DRB3*0101, DQB1*0301, DQB1*0501, and DR1, DR3 (DR17), DR52, DQ7, DQ5. However, it was unusual to find the DR3 (DR17)-DQ7 association, as noted by Cook, Lefor, and van den Berg-Loonen. The normal association is DR17-DQ2, that is, DRB1*0301-DQB1*0201. Lefor commented that DR17-DQ7 was typed in a local DRB1*0317 cell.

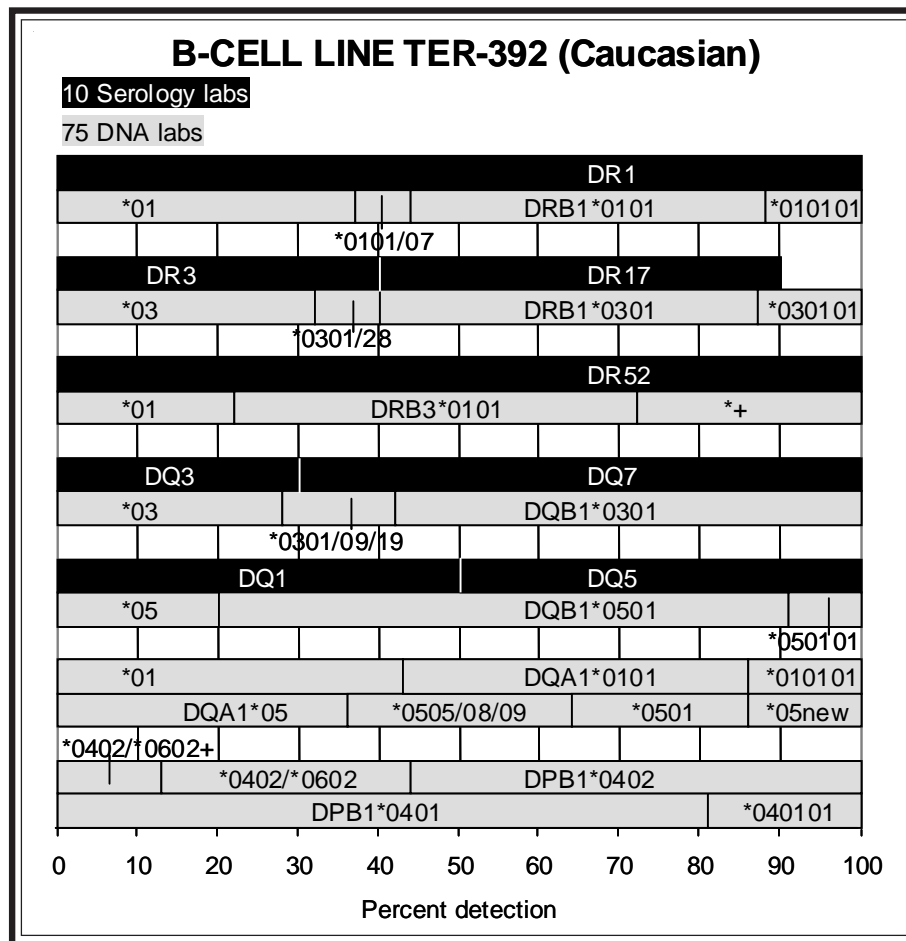

The probable haplotypes in this cell were DRB1*0101-DQB1*0501-DQA1*0101 and the unusual DRB1*0301-DRB3*0101-DQB1*0301-DQA1*05.

Darke assigned DPA1*0103/07/09, -.

The DPB1 types were DPB1*0401 (*040101) and DPB1*0402. Cook and KW Lee noted that DPB1*2301 and DPB1*5101 were possible.

Although DQA1*05 was typed in complete consensus, there was no agreement for which subtype was present. DQA1*0501 was assigned by 22%. KW Lee and van den Berg-Loonen described a new DQA1*05 allele, with the sequence most similar to DQA1*0505, except for one substitution at codon 13 (ACC→GCC), resulting in one amino acid change (threonine to alanine). Van den Berg-Loonen further commented that, when compared to DQA1*0501, there were 2 mismatches, at pos 585 (C→A) and pos 672 (A→G), with no resulting amino acid changes.

Van den Berg-Loonen stated the following, "DRB1*030101 is highly associated with DQB1*0201 and DQB1*0501, whereas DQB1*0301 can be associated with DQA1*0505. Therefore, the new DQA1 allele could originate from a recombination between haplotype DRB1*0301/DQA1*0501/DQB1*0201 and DRB1/DQA1*0505/DQB1*0301. For the DRB1 allele, different possibilities exist, since there are more allele groups that have DQA1*0505/DQB1*0301 (*08, *11, *12, *13). Figure 1 illustrates the recombination event. The breakpoint can be located somewhere between positions 31 and 585."

The class I typing of this cell was A*0101, - B*0801, -, Cw*0701/06.

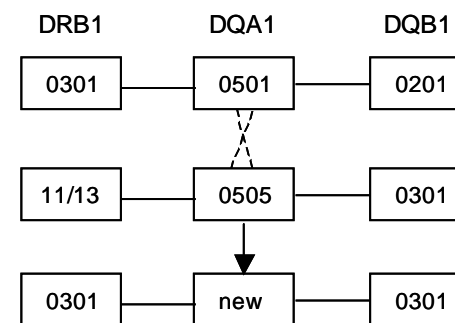
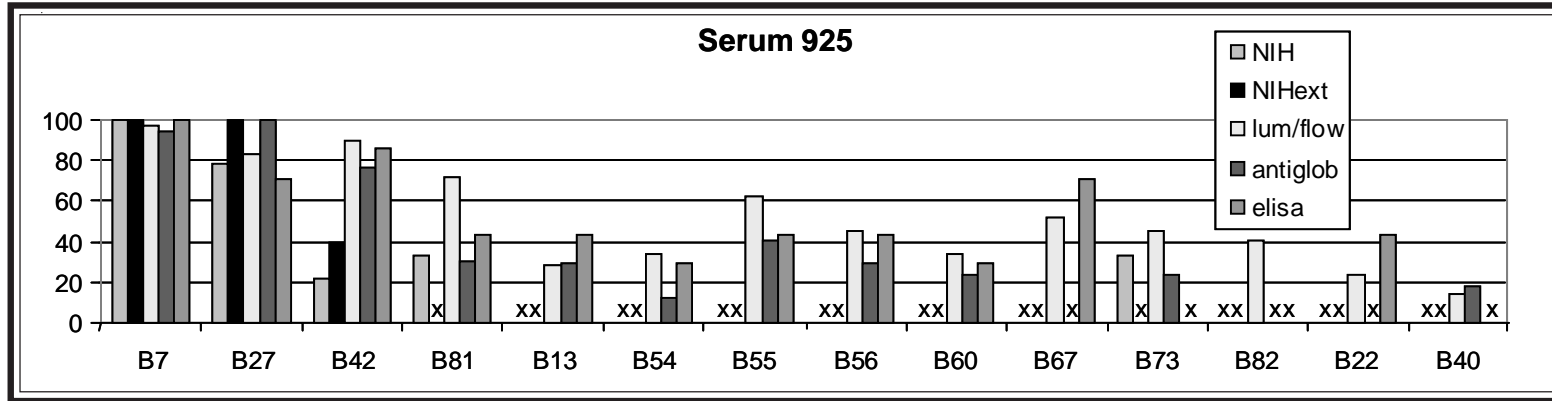

Figure 1. from van den Berg-Loonen, University Hospital Maastricht, 5/31/07.

Serum Exchange



The 4 sera (**925-928**) in this month's study were strongly reactive to B7 and B27 by all methods. Labs using NIH methods also detected anti-B42 and B81 reactivity, whereas those labs using antiglobulin, Luminex, flow, and ELISA, reported reactivity to all 7CREG specificities in general, including B7, B27, B42, B81, B13, B22, B40, B47, B48, B67, B73, and B82. Luminex and flow reported anti-A66 reactivity for sera 926, 927, and 928. Serum 926 was previously screened as serum 818 in 2004.

Serum 927 was previously studied as serum 903 in 2006. Serum 928 was previously screened as sera 844 (2004) and 904 (2006). Since the amino acid residues for B7, B42, B67 and B81 in the alpha one domain are identical, and the amino acid residues for B1303, B54, B55, B56 in the alpha two domain are identical, the results from the different methods may imply that the more sensitive screening assays may bind to additional sites in the alpha two domains. Any comments?

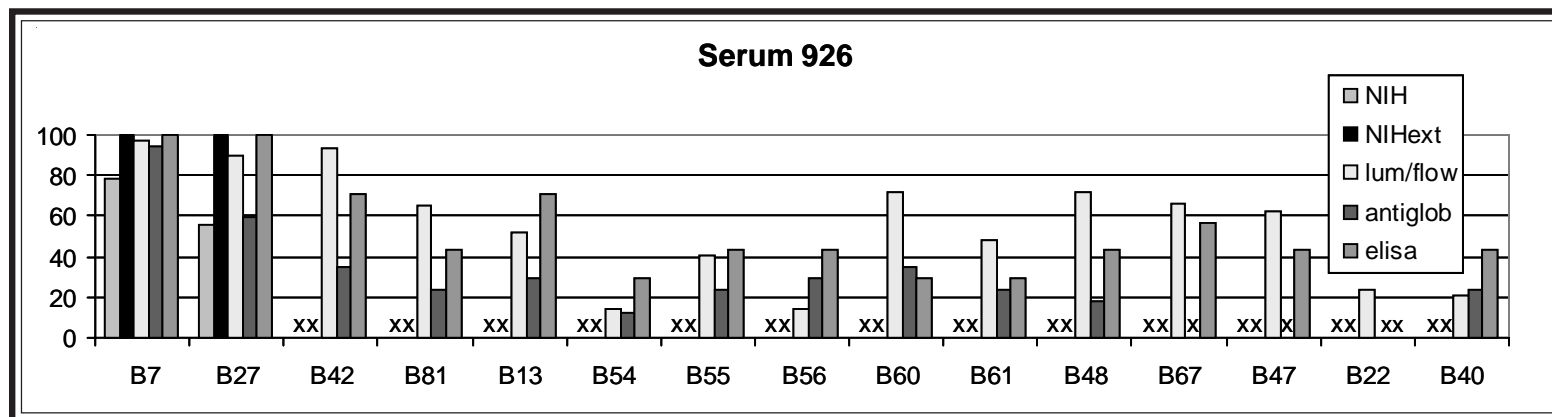

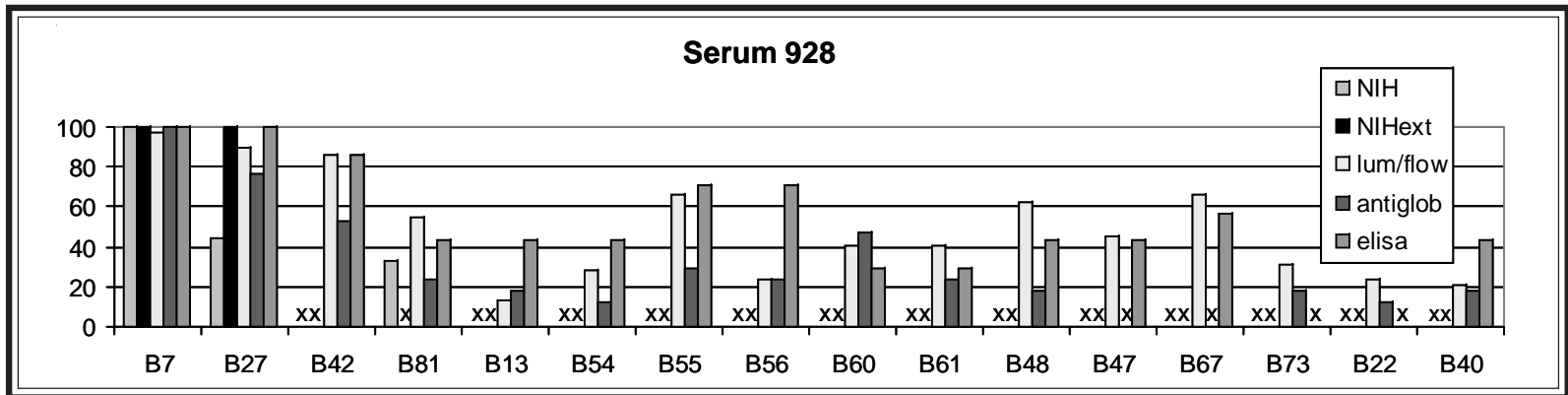
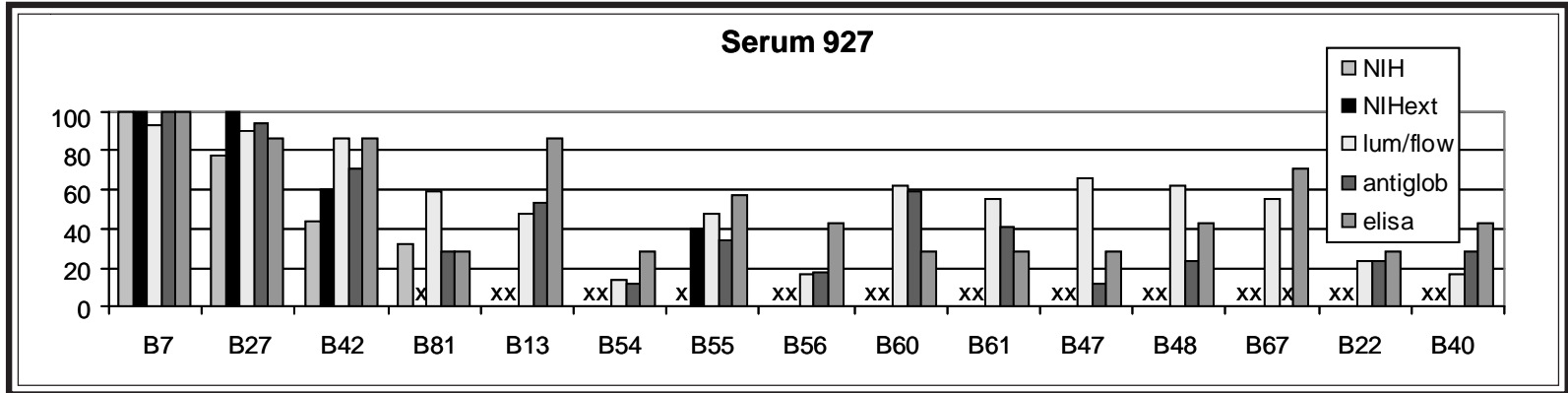

Cook shared the following findings, after performing DNA PCR-RSSOP on DNA extracted from the samples:

Sample ID Suspected sensitizing antigen (in bold)
 Ter 925 A*26, A*32, A*6801/03 group, A*74 (cannot exclude A*66); B*3501/08 group. B*4402/03 (cannot exclude B*1520); Cw*0401 group, Cw*0702 group, Cw*14 (cannot exclude Cw*16).

Ter 926 A*02, A*03 (incomplete typing-exon 3 only); cannot exclude A*69 and A*(19) group; B*1801 group, B*4402 group; Cw*0602 group, Cw*0701 group, Cw*0802 group, Cw*1701 group (cannot exclude Cw*16).

Ter 927 A*0301 group, A*(09) group (23, 24), A*(19) group (32, 74); **B*07** group, B*35 group (cannot exclude B*7801); Cw*0702 group, Cw*0401 group, Cw*0302/03/04 group.

Ter 928 A*6802 group, A*(09) group (23,24), A*74; B*-no product; Cw*0304 group, Cw*0401 group, Cw*0701/02 group (cannot exclude: Cw*0302, 1202, 1402, 1505).

For Ter 927, HLA-B7 is present and suspected to be one of the sensitizing antigens/fetal alleles and is suspected to be a principal immunogen giving rise to HLA antibodies in this sample.

Extract Exchange

We wish to acknowledge **Helen Bass and Christopher Darke, Welsh Blood Service, Pontyclun**, and **Gottfried Fischer and W.R. Mayr, University of Vienna**, for their generous donations of rare cells to study in our exchanges. Three essential reference cells for unusual alleles, including the new A*1115,

B*4702, and B*4703, were examined in this month's study. We congratulate the following labs for identifying these reference cells: Brown, Chen, Moses and Dunckley, McIntyre, and Stamm. Another rare allele, B*3541, was also typed in this exchange.

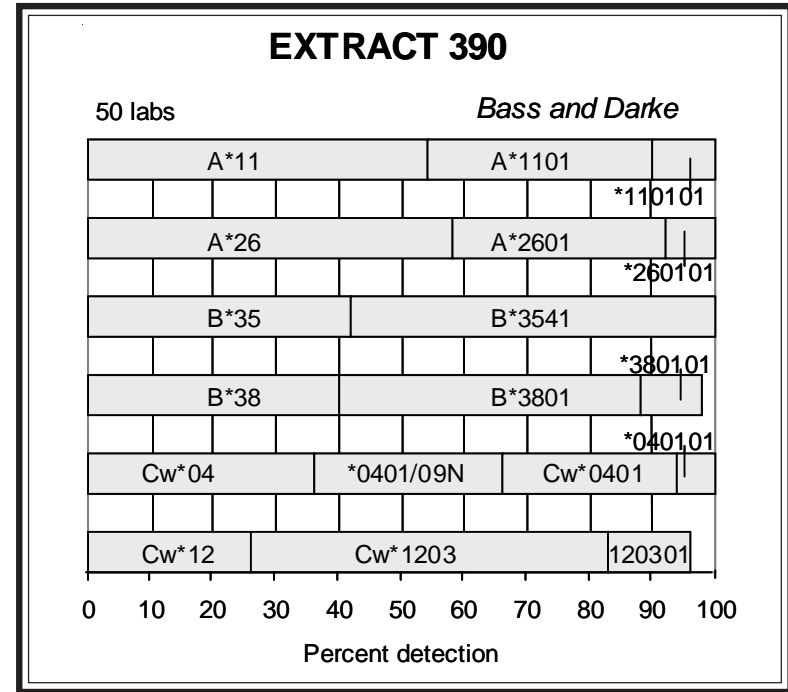
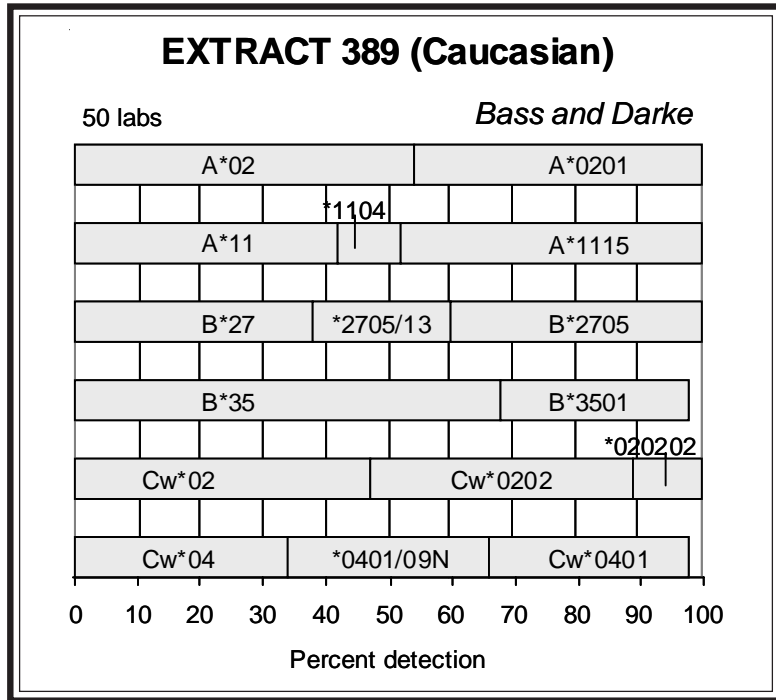

Extract 389. This cell from a Caucasian donor was 36777, also known as NEQ_ED03/03, the reference cell for the new A*1115 (1). This cell was typed as ED03/03 in a 2003 study offered by the UK National External Assessment Scheme for Histocompatibility and Immunogenetics; an A-locus variant was found, as described by Bendukidze et al., "A*1115 is most similar to A*110101 with a single mismatch (G to C) at constant position 565, leading to a conservative amino acid change from valine (GTG) to leucine (CTG) at codon 165 in the alpha two domain." The investigators noted that this difference has not yet been found for any other class I allele.

In this typing, A*1115 (48%) was assigned by nearly half of the labs. It should be noted that 10% misassigned A*1104.

B*2705 (40%) and B*3501 (30%) were the B-locus types. For the B-locus typing, The Anthony Nolan Trust Laboratory detected one substitution

at position 353 (C→T) and postulated a possible B*2705 variant.

Family studies by the investigators revealed the haplotypes in this donor to be A*1115-B*350101-Cw*040101-DRB1*140101-DRB3*020201-DQA1*010401-DQB1*0503-DPA1*0103/07-DPB1*030101 and A*020101-B*270502-Cw*020202-DRB4*0404-DRB4*0103-DQA1*0301-DQB1*0302-DPB1*040101.

Extract 390. This was the second time that the rare B*3541 (58%) was typed in the Cell Exchange. The previous B*3541 exchange cell was extract 337 (2005), which was 41403, also known as WAC 1087870, a reference B*3541 cell.

The second B-locus allele was B*3801 (58%).

The A-locus types were A*1101 (46%) and A*2601 (42%).

B*3541-Cw*0401 and B*3801-Cw*0602 were the likely associations in this cell.

This cell was recently typed as TER-388 and the class II typing was DRB1*0103, DRB1*0701, DRB4*01030102N, DQB1*0303, DQB1*0501,

DQA1*0101, DQA1*0201, DPB1*0301, DPB1*0401. In describing B*3541, Alonso-Nieto et al. (2) noted that 3 unrelated B*3541 donors also had DRB1*0103. This cell had the same B*3541-Cw*0401-DRB1*0103-DQB1*0501 haplotype, as observed in 4 of the 5 reference B*3541 cells.

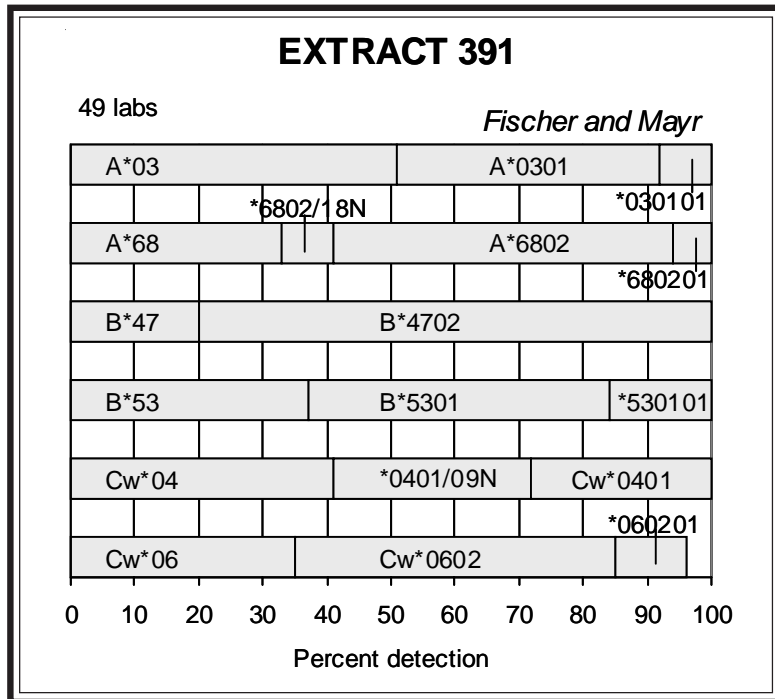

Extract 391. This cell was CAL (3), the reference B*4702 cell, previously typed as extracts 101 (1999) and 309 (2004), as correctly identified by Barnardo, Brown, Chen, Cook, Moses and Dunckley, Montague, and Stamm.

In this present retyping, B*4702 was detected by a high 80%, a marked increase over the 69% detection level in the previous 1999 and 2004 typings. Montague commented upon the “unexpected” Bw6 for a B*47.

The following table indicates the improvement in high-resolution typing of the B-locus alleles over the years:

	extract 101 1999 55 labs	extract 309 2004 58 labs	extract 391 2007 49 labs
A*0301	10%	37%	49%
A*6802	42%	38%	59%
B*4702	69%	69%	80%
B*5301	38%	53%	63%

B*4702-Cw*0602 and B*5301-Cw*0401 were the probable associations.

This cell was also typed for Class II as TER-249 (1999): DRB1*0701, DRB1*1302, DRB3*0301, DRB4*0101, DQB1*0202, DQB1*0604, DQA1*0102, DQA1*0201, DPB1*0401.

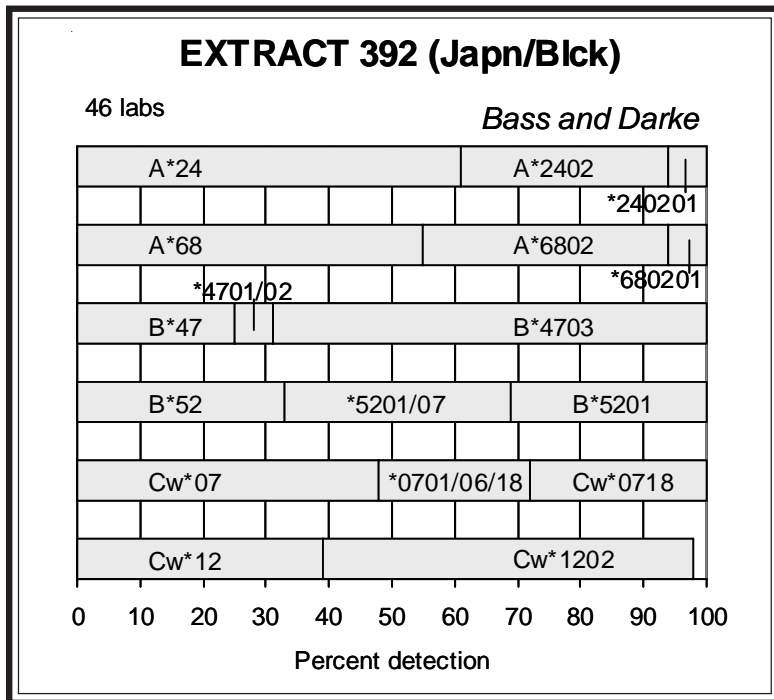

Extract 392. This donor of mixed ethnicity (Black and Japanese), was 29182 (4), a reference cell for B*4703. This was the third B*4703 donor to be typed in the Cell Exchange, the previous cells being extract 117 (2000) (also extract 69, 1998) and cell 1019 (1999) (also cell 977, 1998), both from Black donors.

B*4703 was assigned by 69%. The following table summarizes the typing for this subtype over the years:

	cell 977 Oct-98 38 labs	extract 69 Nov-98 38 labs	cell 1019 Oct-99 51 labs	extract 119 Mar-00 60 labs	extract 392 May-07 49 labs
B*47	21%	11%	22%	25%	25%
B*4701/03	8%	5%	35%	28%	x
B*4702/03	11%	8%	x	14%	x
B*4701	31%	37%	2%	3%	2%
B*4702	5%	18%	2%	2%	4%
B*4703	21%	18%	39%	28%	69%
total	97%	97%	100%	100%	100%

B*5201 was detected by 31%.

A*2402 (39%) and A*6802 (45%) were the A-locus types.

The likely associations in this cell were B*4703-Cw*0718 and B*5201-Cw*1202.

This cell also was typed with the rare DQB1*0608. When recently typed as TER-389, the class II results indicated DRB1*1301 (*130101), DRB1*1502, DRB3*0202, DRB5*0102, DQB1*0601, DQB1*0608, DQA1*0103, DPB1*0602, DPB1*0901.

Cell Exchange

In this month's study, two unusual A24 variants, A*2405 and A*24020102L, were highlighted. In addition, the rare B*5113 was typed.

We wish to acknowledge the following labs for identifying this month's

cells as being previously typed in the Exchange: Barnardo, Brown, Cook, Darke, Dormoy, Moses and Dunckley, Eckels, Harville, Klein, Israel, Lefor, Mah, Stamm, Tiercy, and Ward.

Cell 1301. This Caucasian cell with the rare A*2405 was previously typed as cell 1288 in 2006.

In this present retyping, A23 was assigned by 69% and A24 by 15%, similar to the 2006 results of A23 (71%) and A24 (18%). Varying reactivity to anti-A9, -A23, and -A24 sera were observed by a number of labs, including Abbal, Carretto and Alvarez, Anthony Nolan Trust, Darke, Israel, Klein, Lefor, Mah, Rubocki, Satake, and Steinberg. Anthony Nolan Trust, Klein, Rubocki, and Satake proposed an A23 variant. Lefor observed the same reactivity pattern with monoclonal antibodies as in the previous typing of this A2405 cell, saying "All moab A23 and A24 reagents have had mutually exclusive reactivity in thousands of typings – until now."

A*2405 was reported by 76%, an increase from the 66% detection level in the first typing.

A30 (96%) was verified as A*3001 (50%).

The common associations of B13-Cw6/B*1302-Cw*0602 and B44-Cw5/B*4402-Cw*0501 were present in this donor.

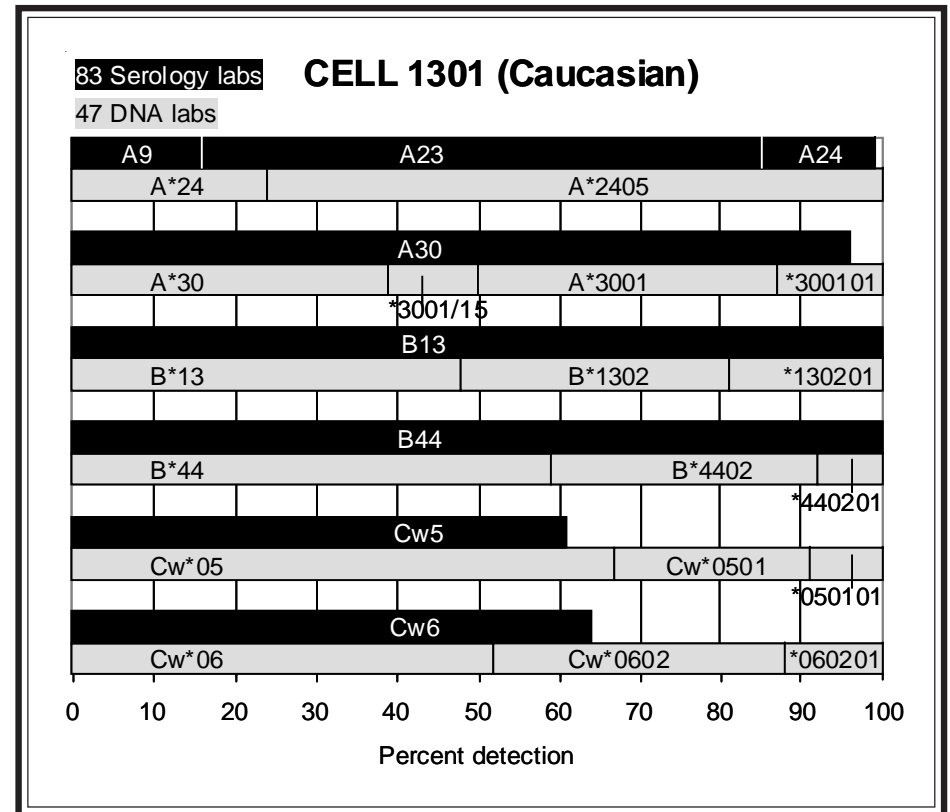

Correction: Cell 1298 in last month's Cell Exchange #325, was the *second* B*1527 cell to be typed in the Cell Exchange. In 2000, B*1527 was typed in cell 1062 from a Chinese donor.

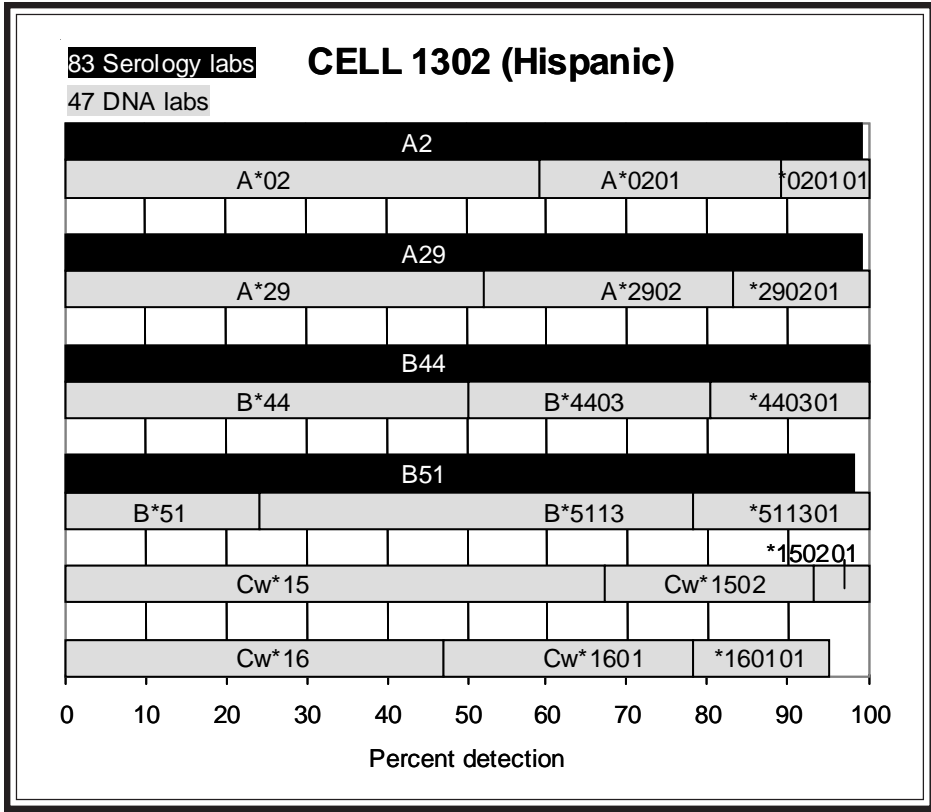

Cell 1302. This cell from an Hispanic donor was previously typed as cell 1271 (2006). An offspring was recently typed as extract 377. Both shared the rare B*5113.

In this present retyping, B51 (98%) was well detected. Abbal and Cook noted weak or short anti-B51 reactivity. B*5113 was assigned by 76%, with B*511301 by 22%.

From the family study, the haplotypes in this cell were determined to be A*0201-B*5113-Cw*1502, the haplotype shared by parent and offspring, and A*2902-B*4403-Cw*1601. The same A*0201-B*5113-Cw*15 was also observed in K60, the reference B*5113 cell, from a South American Indian individual (5).

Cell 1303. This Chinese donor with A*24020102L was previously typed as cell 1284 last year. It was the first time that an antigen with low expression was knowingly studied in the Cell Exchange.

In this present retyping, less than 5% assigned A24, reaffirming the 2006 findings that this low-expressing A24 allele was nearly undetectable by serology. Claas commented that the reactivity of all A9- and A24-specific sera were negative. The following table summarizes the present detection levels for A*24020102L, and indicates that the recognition has improved, with the percent detection level increasing from 31% to 46%.

	cell 1284 2006	cell 1303 2007
A24	90 labs 4%	83 labs 5%
A*24	48 labs 44%	44 labs 36%
A*2402	21%	16%
A*240201	2%	2%
A*24020102L	31%	46%

The probable haplotypes in this donor were A*0207-B*4601-Cw*0102 and A*24020102L-B*0801-Cw*0702. According to Cao et al. (6), the A*0207-B*4601-Cw*0102 was the second most frequently found haplotype in U.S. Asians (HF=0.0413).

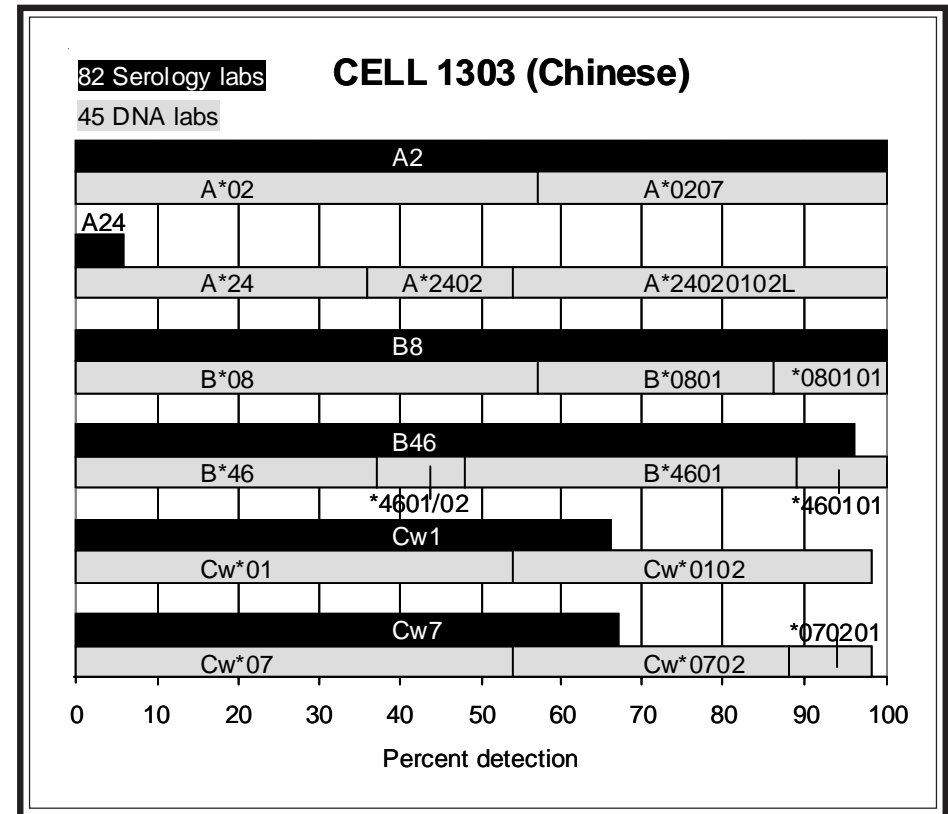

Cell 1304. This Filipino donor was previously typed a number of times in the Cell Exchange, as extract 131 (2000), cell 1084 (2001), cell 1117 (2002). A number of variants, including A3401, B1521, Cw403, found predominantly in Filipino individuals, were present in this cell.

B75 was assigned by 84% and verified as B*1521 (77%).

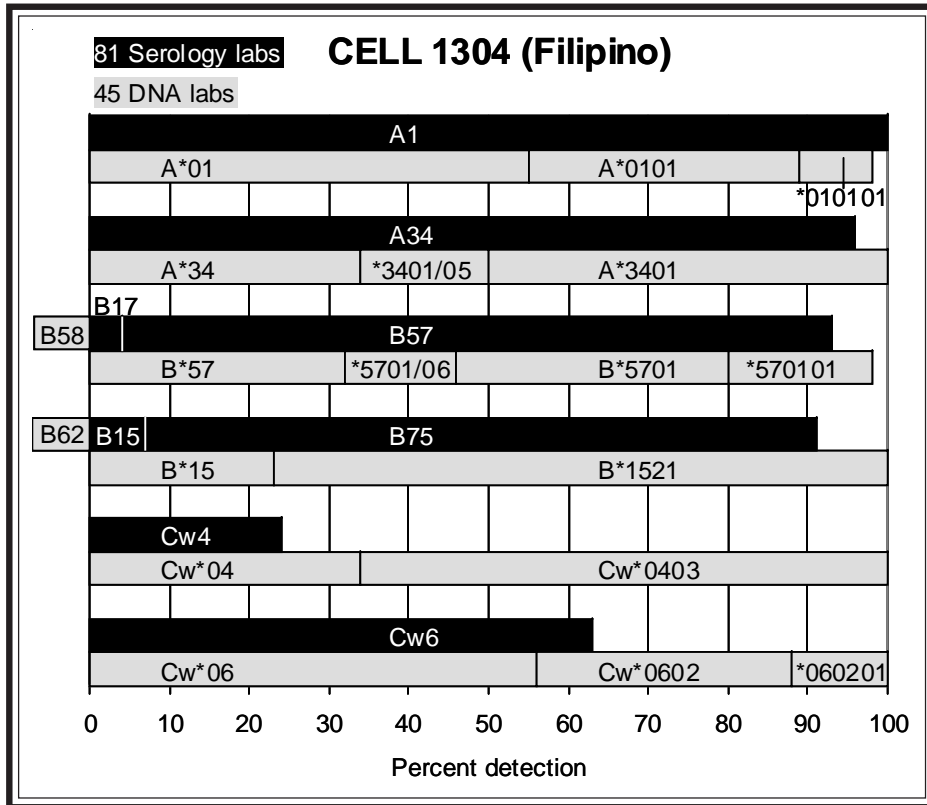

B57 (89%), confirmed as B*5701 (52%), was the second B-locus antigen. The presence of a B15 antigen may often times muddle the serological differentiation of a B17 split. The following figure follows the detection of B75 and B*1521 in this cell between 2000 and 2007.

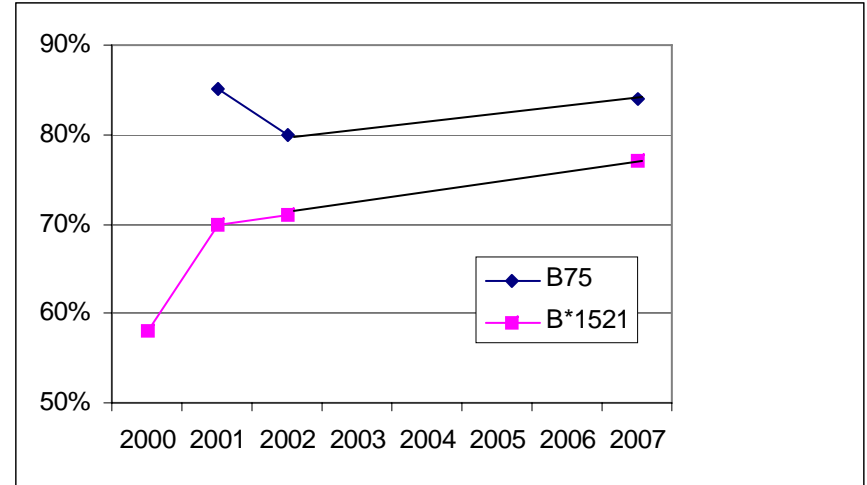

Cw4 (23%) and Cw6 (63%) were corroborated as Cw*0403 (66%) and Cw*0602 (44%), respectively. Dunk noted a short Cw4; Darke commented that the presence of Cw6 masked the detection of Cw403.

A1 (100%) and A34 (96%) were well detected, attaining over 95% agreement. A*0101 (43%) and A*3401 (50%) were the alleles present.

The likely haplotypes in this cell were A*0101-B*5701-Cw*0602 and A*3401-B*1521-Cw*0403.

References

1. Bendukidze N, Day S, Street J, et al. Identification of a novel HLA-A (A*1115) in the UK National External Quality Assessment Schemes for Histocompatibility and Immunogenetics' Educational Cell Exchange. *Tissue Antigens* 2006;67:153.
2. Alonso-Nieto M, Garcia-Sanchez, Lillo R, et al. Four new HLA class I alleles in Cauacasoids. *Tissue Antigens* 2005;66:51.
3. Fischer GF, Broer E, Fae I, et al. Nucleotide sequence analysis of an HLA-B47 variant (HLA-B*4702). *Tissue Antigens* 1997;49:540.
4. Darke C, Guttridge MG, Street J, et al. HLA-B*4703: sequence confirmation, serology, and distribution. *Tissue Antigens* 1999;53:586.
5. Scott I, Dunn, PPJ, Day S, et al. A novel HLA allele, HLA-B*5113, identified in the Kolla Amerindians of North-West Argentina. *Tissue Antigens* 1996;53:194.
6. Cao K, Hollenbach J, Shi X, et al. Analysis of the frequencies of HLA-A, B, and C alleles and haplotypes in the five major ethnic groups of the United States reveals high levels of diversity in these loci and contrasting distribution patterns in these populations. *Hum Immunol* 2001;62:109.

NEXT MAILING DATE: August 8, 2007

Marie Lau, Min S. Park, J. Michael Cecka, and Elaine F. Reed

 * *
 * PARTICIPATING CENTERS *
 * *

NAME	CITY STATE/COUNTRY	NAME	CITY STATE/COUNTRY	NAME	CITY STATE/COUNTRY
(W.H.O. LABS)		Gideoni,Osnat	Haifa	Norin,Dr Allen	Brooklyn NY
-----	-----	Gillespie,Dr Kathlee	Bristol	Olerup,Olle	Saltsjobaden
Mayr,Prof W.R.	Vienna	Gladman/Pellett,	Toronto ON	Ozawa,Mikki	Los Angeles CA
-----	-----	Goggins,R.	New Haven CT	Pahl,Dr Armin	Geesthact
Abbal,Prof M.	Toulouse Cedex	Graff,Dr Ralph J.	St Louis MO	Paik MD,Young K.	Honolulu HI
Adams,Sharon	Bethesda MD	Hahn PhD,Amy B.	Albany NY	Pais,Dr Maria Luisa	Coimbra
Allegheny General Ho	Pittsburgh PA	Hajeer,Dr Ali	Riyadh	Pancoska PhD,Carol	Springfield NJ
Alonso,Antonio	Malaga	Hamdi,Dr Nuha	Riyadh	Park MD,Myoung Hee	Seoul
Alvarez & Carrett,Dr	Montevideo	Han,Dr Hoon	Seoul	Park,Jong-Sun	Seoul
Anthony Nolan Trust	London England	Harville/ACH,	Little Rock AR	Partanen PhD,Jukka	Helsinki
Balazs,Ivan	Stamford CT	Harville/UA,	Little Rock AR	Pereira,Noemi F.	Curitiba Paran
Ball,Dr Edward	London ON	Henrico Doctors' Hos	Richmond VA	Phelan,Donna	St Louis MO
Barnardo,Dr Martin	Oxford England	Hidajat,Melanny	Brugge	Pollack PhD,Marilyn	San Antonio TX
Baxter-Lowe,Dr Lee A	San Francisco CA	Hogan,Dr Patrick	Herston QLD	Rajczyk & Gyodi,Dr	Budapest
Berka PhD,Noureddine	Washington DC	Holdsworth,Rhonda	South Melbourn	Reed PhD,Elaine F.	Los Angeles CA
Blasczyk,Prof Rainer	Hannover	Hsu PhD,Susan H.	Philadelphia PA	Reed PhD,Elaine F.	Los Angeles CA
Bow PhD,Laurine	Hartford CT	Hubbell,Charlene	Syracuse NY	Reinke MD,Dennis	Bismarck ND
Brown,Dr Colin	London England	Hurley & Hartzma,Dr	Rockville MD	Reinsmoen PhD,Nancy	Los Angeles CA
Bunce,Dr Mike	Bromboroug,Wir	Ichikawa MD PhD,Yasu	Nishinomiya,Hy	Richard,Lucie	Sainte-Foy QC
Burger,Joe	Columbia MO	Israel,Dr Shoshana	Jerusalem	Rosen-Bronson PhD,Sa	Washington DC
Cantwell,Linda	Parkville	Iwaki,Dr Yui	Loma Linda CA	Rosenberg MD,J.C.	Ann Arbor MI
Carrington & Martin,	Frederick MD	Kamoun MD,Malek	Philadelphia PA	Rubocki PhD,Ronald	Scarborough ME
Cecka PhD,Michael	Los Angeles CA	Kato MD,Shunichi	Isehara,Kanaga	Sage,Dr Deborah	London England
Chan MD,Prof Soh Ha	Singapore	Keown MD,Paul	Vancouver BC	Satake MD,Masahiro	Tokyo
Charlton PhD,Ronald	Jacksonville FL	Kim MD,Kyeong-Hee	Pusan	Sauer,Norbert	Lich
Charoenwongse MD,Pre	Bangkok	Kim,Prof Tai-Gyu	Seoul	Schroeder MD,M.L.	Winnipeg MB
Charron,Prof D.	Paris Cedex 10	Klein MD,Jon	Louisville KY	Scornik,Dr Juan C.	Gainesville FL
Chen,Dr Dongfeng	Durham NC	Klein,Dr Tirza	Petach Tikva	Semana MD PhD,Gilber	Rennes
Chongkolwatana & Vej	Bangkok	Kohara,Setsuko	Nagoya, Aichi	Senitzer PhD,David	Duarte CA
Choo MD,Yoon	Valhalla NY	Kopko MD,Patricia	Sacramento CA	Shainberg PhD,Bracha	Rehovot
Christiansen & Wit,	Perth - West A	Kotsch PhD,Katja	Berlin	Smith/Baylor,	Dallas TX
Ciccia/Williams,	San Diego CA	KuKuruga PhD,Debra	Baltimore MD	Smith/MI,	Ann Arbor MI
Claas,Prof F.H.J.	Leiden	Kusnierczyk,Piotr	Wroclaw	Snider PhD,Denis	Buffalo NY
Cohen & Sumyuen,	Reims	Kvam,Vonnett	Waukesha WI	Spannagl,Dr Michael	Munich
Colombe PhD,Beth W.	Philadelphia PA	Land,Dr Geoffrey A.	Houston TX	Stamm,Luz	Calgary AB
Cook PhD,Daniel J.	Cleveland OH	Lardy,Dr N.M.	Amsterdam	Stavropoulos-Gi,Dr C	Athens
Costeas,Dr Paul A.	Nicosia	Lazda PhD,Velta A.	Elmhurst IL	Steinberg,Karen	Canoga Park CA
Crowe PhD,Deborah	Nashville TN	Lebeck PhD,Lauralynn	La Jolla CA	Stewart,Dod	New Orleans LA
Daniel PhD,Claude	Laval PQ	Lee MD,Wee Gyo	Suwon	Suciu-Foca PhD,Nicol	New York NY
Daniel,Dr Dolly	Tamil Nadu	Lee PhD,Kyung Wha	Anyang,Kyungki	Sullivan PhD,Karen	New Orleans LA
Danilovs PhD,John	Phoenix AZ	Lee,Dr Jar-How	Canoga Park CA	Tagliere,Jacque	Los Angeles CA
Darke,Dr Christopher	Pontyclun Wale	Leech MD PhD,Stephen	Philadelphia PA	Tavoularis,Dr Sofia	Ottawa ON
Davidson & Poulton,D	Manchester, En	Lefor PhD,W.M.	Tampa FL	Tbakhhi,Dr Abdelghani	Riyadh
Davis PhD,Mary	Stamford CT	Lo MD,Raymundo W.	Quezon City	Thoni MD,Deborah	Orlando FL
Dinauer,David	Brown Deer WI	Loewenthal MD PhD,Ro	Tel-Hashomer	Tiercy,Dr Jean-Marie	Geneva 14
Dormoy,Dr Anne	Strasbourg	Lopez-Larrea PhD,Car	Oviedo	Trachtenberg PhD,Eli	Oakland CA
Du PhD,Keming	Shanghai	MacCann,Eileen	Providence RI	Trowsdale,Prof John	Cambridge
Du Toit MD,Ernette	Cape Town	Mah,Helen	Boston MA	Turner PhD,E.V.	Memphis TN
Dunckley PhD,Heather	Sydney NSW	Mani,Dr Rama	Chennai,Tamil	Uhrberg,Dr Markus	Dusseldorf
Dunk,Arthur	Lauderhill FL	Marcos,Cintia Y.	Buenos Aires	Vaidya PhD,Smita	Galveston TX
Dunn PhD,Paul	Auckland	Marsh,Dr Steven	London England	Van Den Berg-Lo,Prof	Maastricht
Dunn,Dr Dale	Lubbock TX	Masuo,Kiyoe	Tokyo	Varnavidou-Nico,Dr A	Nicosia
Dupont MD,Bo	New York NY	McAlack PhD,Robert	Philadelphia PA	Vidan-Jeras,Blanka	Ljubljana

Duquesnoy PhD,Rene	Pittsburgh	PA	McAlack-Balasub,	Philadelphia	PA	Vilches,Dr Carlos	Madrid	
Eckels/CPMC,	San Francisco	CA	McCluskey,Prof James	Adelaide		Walter Reed Army Med	Washington	DC
Eckels/Utah,	Salt Lake City	UT	McIntyre PhD,John A.	Beech Grove	IN	Ward,Dr William	Hyattsville	MD
Ellis PhD,Thomas	Milwaukee	WI	Middleton,Prof Derek	Belfast		Wassmuth,Prof Ralf	Dresden	
Esquenazi PhD,Violet	Miami	FL	Miller,Dr Joshua	Miami	FL	Watkins PhD,David I.	Madison	WI
Esteves-Kondo,Debra	Canoga Park	CA	Montague,Bridget	Leeds England		Wernet,Prof Peter	Dusseldorf	
Fernandez-Vina PhD,M	Houston	TX	Moore MD,S.Breannndan	Rochester	MN	Williams,Marj	Allentown	PA
Fotino MD,Marilena	New York	NY	Murad,Dr Shahnaz	Kuala Lumpur		Wisecarver PhD,James	Omaha	NE
Foxcroft,Z.K.	Johannesburg		Mytilineos MD,Joanni	Ulm		Yamamori PhD,Shunji	Tokyo	
Furukawa,Yoko	Yokohama,Kanag		Nehlsen-Cannare,Dr S	Detroit	MI	Yu_Neng/ARC,	Dedham	MA
Gardiner PhD,Clair M	Dublin		Noche,Olivia	Brown Deer	WI	Yu_Neng/UMMMC,	Worcester	MA
Gautreaux,Dr Michael	Winston-Salem	NC	Noreen,Harriet	Minneapolis	MN	Zachary PhD,Andrea	Baltimore	MD

B-CELL LINE TER-391

CTR DIRNAME	DRB1	DRB1X	DRB3	DRB4	DQB1	DQB1X	DQA1	DQA1X	DPB1	DPB1X	METHOD
4079 Abbal,M.	*0315	*0407	*0202	*0103	*0201/05	*0302/03+					P-SSO,SSP
5488 Adams,Sharon	*0315	*040701	*+	*+	*020101	*030201	*0301	*0501	*0202	*0402	SSP,SBT
2300 Allegheny Ge	*03	*04	*+	*+	*02	*03					SSP
105 Ball,Edward	*0315	*0407	*0202	*0103	*0201/05	*0302	*030101	*0501	*0202	*0402	P-SSP
2020 Barnardo,Mar	*0301/11+	*0407	*0202/05+	*0101-07	*0201	*0302/11	*0301-03	*0501	*0202	*0402/*0602	SSP
785 Chan,So Ha	*0314/15	*0403/07	*+	*01	*0201	*0302	*0301-03	*0501+			SBT
5232 Charlton,Ron	*0315	*0407	*01-*03	*01-*03	*0201	*0302					SSP
4492 Charron,D.	*0315	*0407	*0202	*0103	*0201/04	*0302	*0301	*0501	*0202	*0402	P-SSP,SSO
3224 Chen,Dongfen	*0315	*0407	*0202	*0103	*0201	*0302					SBT,SSO,SSP
3966 Chongolwatan	*0315	*0407	*0202	*0103	*0201	*0302					P-SSP
3632 Colombe,Beth	*0315	*0407	*0202	*0103	*0201	*0302					SSP
16 Cook,Daniel	*0315	*040701	*0202	*0103	*02	*0302	*03	*05	*0202	*0402/*0602	RSSO,SSP,SBT
5130 Costeas,Paul	*0315	*0407	*0202	*0103	*0201		*0301	*0501			SSP
779 Daniel,Claud	*03(DR17)	*04	*01-*03	*01010101+	*02	*03(DQ8)					P-SSP
5219 Daniel,Dolly	*03	*04	*+	*+							P-SSP
3625 Darke,Chris	*0315	*0407	*02	*01	*0201	*0302	*03	*05	*0202/03	*0402	P-SSP
4269 Dormoy,Anne	*0315	*040701	*020201	*0103	*0201	*0302			*0202	*0402	P-SSP,SBT
5891 Du,Keming	*0301/05+	*0403/06/07									P-SSO
3766 Dunn,Paul	*0315	*0407	*0202/12	*0101-06	*0201-04	*0302					SSO
856 Dupont,Bo	*0314/15	*0403/07/50	*02	*+	*0201/02	*0302/07					RVSSO
3511 Duquesnoy,Re	*0301	*0407	*0202	*0103	*0201	*0302					RVSSOP,SSP
5214 Eckels/CP	*03(DR17)	*0407	*0201	*01	*02	*0302					SSOP
3428 Eckels/Utah	*0301/15	*0407									SSOP
4251 Ellis,Thomas	*0315	*0407	*0202/12	*0101/03/06	*0201	*0302					P-SSO,SEQ
762 Fischer/Mayr	*0315	*0407	*0202	*0101/03/06	*0201/04	*0302					SSO,LBT,SBT
8043 Gideoni,Osna	*0315	*0407			*0201	*0302					
910 Hahn,Amy	*0315	*0407	*0202	*0103	*0201/04	*0302					SSP
4691 Hajeer,Ali	*13	*04	*+	*+	*02	*03					
2344 Hurley/Hartz	*0315	*040701			*020101	*030201					SBT,SSOP
771 Israel,Shosh	*0301	*0407			*0201	*0302					RVSSO,SSP
3261 Iwaki,Yui	*0315	*0407	*+	*+	*0201	*0302			*0202	*0402	SSP
859 Kamoun,Malek	*0315	*0407	*0202	*0103	*0201	*0302					P-SSO,SSP
797 Kato,Shunich	*0315	*0407			*0201-03+	*0302					SBT,SSO
4864 Kim,Kyeong-H	*03	*04									P-SSOP
4337 Kim,Tai-Gyu	*0315	*0407			*0201	*0302			*0202	*0402/*0602	SBT
168 Klein,Tirza	*0301	*0407	*0202	*0103	*0201	*0302					P-SSP
87 Land,Geoffre	*0315	*0407	*0202	*0103	*0201	*0302	*0301	*0501	*0202	*0402	SBT,SSP
748 Lazda,Velta	*03	*04	*+	*+	*02	*03					P-SSP
278 Lee,Jar-How	*0315	*0407	*0202	*0103	*0201	*0302	*0301	*0501	*0202/03	*0402/*0602+	SSP,RVSSOP
640 Lee,Kyung Wh	*0315	*0407			*0201	*0302	*030101	*050101	*0202	*0402	P-SBT
6649 Lee,Wee Gyo	*03	*04	*+	*+							P-SSP
759 Lefor,W.M.	*0301/15	*0407			*02	*0302					RVSSO
274 Lo,Raymundo	*0301	*04	*+	*+	*02	*0302					SSP
731 Loewenthal,R	*0315	*040701			*0201/02/04	*030201/07					SBT,SSP
23 Mah,Helen	*0315	*0407	*0202	*01	*0201	*0302					P-RFLP,SSP
8029 Mani,Rama	*03	*04	*+	*+	*02	*03					SSP
9916 McIntyre,Joh	*0315	*040701	*0202	*0103	*0201	*0302					SBT,SSP
8021 Montague,Bri	*0304/11+	*0401-0301+	*0107/*02	*0101-0301+	*0201	*0302			*0202	*0402/*0602	P-SSP
792 Moore,S.Brea	*03(DR17)	*04	*+	*+	*02	*03(DQ8)					P-SSP
5323 Murad,Shahna	*0315	*0407	*0202	*01	*02	*03					P-SSP
774 Paik,Young K	*0315	*0407	*0202	*0103	*0201/04	*0302					SSP,SSOP
8001 Pancoska,Car	*0315	*0407	*0202	*0103	*0201/04	*0302					RVSSO,SSP
5096 Park,Jong-Su	*03	*04									SSOP
3648 Pereira,Noem	*0315	*040701			*020101	*030201					P-RVSSO,SBT
2400 Phelan,Donna	*0315	*0407	*02	*0103	*0201	*0302					RVSSO,SSP
4689 Rajczy&Gyodi	*0315	*0407	*0202	*0103	*0201/05	*0302					P-SSP
3753 Reed,Elaine	*0315	*0407	*0202	*0103	*0201	*0302	*0301	*0501			SBT,SSP

B-CELL LINE TER-391

77 DNA LABS

77 LABS REPORTING DRB1

DRB1*03	29%
DRB1*0301	5%
DRB1*0315	65%
DRB1*03	99% TOTAL

DRB1*04	26%
DRB1*0407	62%
DRB1*040701	12%
DRB1*04	100% TOTAL

60 LABS REPORTING DRB3

DRB3*+	33%
DRB3*0201	2%
DRB3*0202	45%
DRB3*020201	3%
DRB3*02	17%

60 LABS REPORTING DRB4

DRB4*+	31%
DRB4*0103	43%
DRB4*010301	2%
DRB4*01030101	2%
DRB4*01	22%

10 SEROLOGY LABS

DR3	40%
DR17	20%
DR18	10%
DR3	70% TOTAL

DR4	100%
-----	------

DR52	100%
------	------

DR53	100%
------	------

71 LABS REPORTING DQB1

DQB1*02	32%
DQB1*0201/04	9%
DQB1*0201	52%
DQB1*020101	7%
DQB1*02	100% TOTAL

DQB1*03	24%
DQB1*0302	68%
DQB1*030201	7%
DQB1*03	99% TOTAL

14 LABS REPORTING DQA1

DQA1*03	36%
DQA1*0301	43%
DQA1*030101	21%
DQA1*03	100% TOTAL

DQA1*05	29%
DQA1*0501	57%
DQA1*050101	14%
DQA1*05	100% TOTAL

17 LABS REPORTING DPB1

DPB1*02	12%
DPB1*0202	88%
DPB1*02	100% TOTAL

DPB1*0402	59%
DPB1*0402/*0602	29%
DPB1*0402/*0602+	12%

DQ2	100%
-----	------

DQ3	9%
-----	----

DQ8	91%
-----	-----

DQ3	100% TOTAL
-----	------------

B-CELL LINE TER-392

CTR DIRNAME	DRB1	DRB1X	DRB3	DQB1	DQB1X	DQA1	DQA1X	DPB1	DPB1X	METHOD
4079 Abbal,M.	*0101	*0301	*0101	*0301/04/09+	*0501					P-SSO,SSP
5488 Adams,Sharon	*010101	*030101	*01	*03	*05	*0101	*05	*0401	*0402	SSP,SBT
2300 Allegheny Ge	NT									SSP
105 Ball,Edward	*0101	*0301	*0101	*0301/19	*0501	*0101	*0501	*0401/*6601	*0402	P-SSP
2020 Barnardo,Mar	*0101/05/07+	*0301/11/15+	*0101/03+	*0301/09/10+	*0501	*0101/04+	*0505/08+	*0401	*0402	SSP
785 Chan,So Ha	*010101	*030101	**	*0301/13	*0501	*0101/04+	*0501+			SBT
5232 Charlton,Ron	*0101	*0301	*01-*03	*0301	*0501					SSP
4492 Charron,D.	*0101	*0301	*0101	*0301	*0501	*0101	*0501	*0401	*0402/*0602	P-SSP,SSO
3224 Chen,Dongfen	*0101	*0301	*0101	*0301	*0501					SBT,SSO,SSP
3966 Chongolwatan	*0101	*0301	*0101	*0301	*0501					P-SSP
3632 Colombe,Beth	*0101	*0301	*0101	*0301	*0501					SSP
16 Cook,Daniel	*010101	*030101	*0101	*0301/09	*0501	*01	*05	*040101//+	*0402/*0602//+	RSSO,SSP,SBT
5130 Costeas,Paul	*0101/08	*0301/18	*0101	*0301	*0501/03	*0101	*0505/08			SSP
779 Daniel,Claud	*01	*03(DR17)	*01-*03	*03(DQ7)	*05					P-SSP
5219 Daniel,Dolly	*01	*03	**							P-SSP
3625 Darke,Chris	*0101	*0301	*01	*0301	*0501	*0101	*05	*0401	*0402	P-SSP
4269 Dormoy,Anne	NT									P-SSP,SBT
5891 Du,Keming	*0101/05/07/08	*0301/04-06								P-SSO
3766 Dunn,Paul	*01	*03	*0101-05	*0301/09	*0501					SSO
856 Dupont,Bo	*0101	*0301	*01	*0301	*0501					RVSSO
3511 Duquesnoy,Re	*0101	*0301	*0101	*0301	*0501					RVSSOP,SSP
5214 Eckels/CP	*01	*03(DR17)	*01	*03(DQ7)	*0501					SSOP
3428 Eckels/Utah	*0101/05/07+	*0301/13/18+								SSOP
4251 Ellis,Thomas	*0101/07	*0301	*0101/02/04	*0301	*0501					P-SSO,SEQ
762 Fischer/Mayr	*0101	*0301	*0101	*0301/09	*0501					SSO,LBT,SBT
8043 Gideon,Osna	*0101	*0301		*0301	*0501					
910 Hahn,Amy B.	*0101/13	*0301/28	*0101	*0301	*0501					SSP
4691 Hajeer,Ali	*01	*03	**	*03	*05					
2344 Hurley/Hartz	*010101	*030101		*030101/19	*050101					SBT,SSOP
771 Israel,Shosh	*0101	*0301		*0301	*0501					RVSSO,SSP
3261 Iwaki,Yui	*0101	*0301	**	*0301	*0501			*0401	*0402	SSP
859 Kamoun,Malek	*0101	*0301	*0101	*0301	*0501					P-SSO,SSP
797 Kato,Shunich	*0101/07	*0301		*0301/09	*0501					SBT,SSO
4864 Kim,Kyeong-H	*01	*03								P-SSOP
4337 Kim,Tai-Gyu	*0101	*0301		*0301	*0501			*0401	*0402/*0602	SBT
168 Klein,Tirza	*0101	*0301	*0101	*0301	*0501					P-SSP
87 Land,Geoffre	*0101	*0301	*0101	*0301	*0501	*0101	*0501	*0401	*0402	SBT,SSP
748 Lazda,Velta	*01	*03	**	*03	*05					P-SSP
278 Lee,Jar-How	*0101	*0301/28	*0101	*0301	*0501	*0101/04+	*0505/09	*0401/*2301	*0402/*0602+	SSP,RVSSOP
640 Lee,Kyung Wh	*0101	*0301		*0301	*0501	*010101	*0505v	*0401/**2301	*0402/**5101	P-SBT
6649 Lee,Wee Gyo	*01	*03	**							P-SSP
759 Lefor,W.M.	*0101/05/07+	*0301/13/18+		*0301/09	*0501					RVSSO
274 Lo,Raymundo	*01	*0301	**	*0301	*05					SSP
731 Loewenthal,R	*010101	*030101		*030101/09+	*050101					SBT,SSP
23 Mah,Helen	*0101	*0301	*0101	*0301	*050101					P-RFLP,SSP
8029 Mani,Rama	*01	*03	**	*03	*05					SSP
9916 McIntyre,Joh	*010101	*030101	*0101	*0301/19	*0501					SBT,SSP
8021 Montague,Bri	*010101	*0301/06/13+	*01	*0301	*0501			*0401	*0402/*0602	P-SSP
792 Moore,S.Brea	*01	*03(DR17)	**	*03(DQ7)	*05					P-SSP
5323 Murad,Shahna	*0101/13	*0301/28	*01/*02	*03	*05					P-SSP
774 Paik,Young K	*0101/14	*0301/28	*0101	*0301	*0501					SSP,SSOP
8001 Pancoska,Car	*0101/14	*0301/28	*0101	*0301	*0501					RVSSO,SSP
5096 Park,Jong-Su	*01	*03								SSOP
3648 Pereira,Noem	*0101/07	*030101		*030101	*050101					P-RVSSO,SBT
2400 Phelan,Donna	*0101	*0301/16/18+	*01	*0301	*0501					RVSSO,SSP
4689 Rajczyk&Gyodi	*0101	*0301/32	*0101	*0301/19	*0501					P-SSP
3753 Reed,Elaine	*0101/07	*0301	*0101	*0301	*0501	*0101/04+	*0505/09			SBT,SSP

B-CELL LINE TER-392

CTR DIRNAME	DRB1	DRB1X	DRB3	DQB1	DQB1X	DQA1	DQA1X	DPB1	DPB1X	METHOD
782 Richard, Luci	*0101	*0301		*0301/19	*0501					SSO, SSP
1160 Rosen-Bronso	*01	*03	*01	*03	*05					RVSSO, SSP
793 Rubocki, Rona	*01	*03	++	*03(DQ7)	*05					SSP
8042 Shainberg, Br	*0101	*0301		*0301	*0501					P-SSP
5133 Smith/Baylor	*0101	*0301	*0101	*0301	*0501					SSP, SBT
735 Smith/MI	*0101	*0301	++	*0301	*0501					SSP, RVSSOP
746 Stamm, Luz	*0101/14	*0301/28	*01	*0301	*0501					RVSSOP, SSP
3904 Stewart, Dod	*0101/04	*030101	*0101	*0301	*0501					P-SSP
13 Tagliere, Jac	*0101	*0301	*0101	*0301	*0501					SSP
2332 Tbakhi, Abdel	*0101	*0301	*01-*03	*0301	*0501					SSP
747 Tiercy, Jean-	*0101	*0301	*0101	*0301	*0501			*0401	*0402	
4021 Trachtenberg	*01	*03	*01	*03	*0501					RVSSO
5462 Turner, E.V.	*0101	*0301	*0101	*0301	*0501					SSP
5451 Van den Berg	*010101	*030101	*010102	*030101	*050101	*010101	*05new	*040101	*0402	SBT
5642 Varnavidou-N	*0101	*0301	++	*0301	*0501					P-SSP
705 Watkins, Dav	*0101/07	*0301	*010101g+	*030101g	*050101+					SSP, SEQ
3135 Wernet, Peter	*0101	*0301	*0101	*0301	*0501			*0401	*0402/*0602+	SBT, P-SSP
5670 Williams, Mar	*01	*03	++	*03	*05					SSP
2847 Yamamori, Shun	*01	*03		*03	*05					SSP
1466 Yu_Neng/ARC	*010101	*030101		*030101/09+	*050101	*0101/04+	*0501+	*040101	*0402/*0602	SSP, SSOP, SBT

CTR DIRNAME	DR1	DR3	DR52	DQ7	DQ5	OTH1	OTH2
16 Cook, Daniel	+	+	+	+	+	DR14	
3766 Dunn, Paul	+	DR17	+	+	DQ1		
2200 Furukawa, Yok	+	+	+	+	+		
910 Hahn, Amy B.	+	DR17	+	+	DQ1	DR18	
4908 Kvam, Vonnet	+	DR17	+	DQ3	DQ1		
725 Lardy, N.M.	+	+	+	DQ3	DQ1		
54 McAlack, Robe	+	+	+	+	+	DR13	
2400 Phelan, Donna	+	DR17	+	DQ3	DQ1		
793 Rubocki, Rona	+	+	+	+	+		
3904 Stewart, Dod	+	DR17	+	+	+		

B-CELL LINE TER-392 (Caucasian)
75 DNA LABS

75 LABS REPORTING DRB1

DRB1*01	37%
DRB1*0101/07	7%
DRB1*0101	44%
DRB1*010101	12%
DRB1*01	100% TOTAL
DRB1*03	32%
DRB1*0301/28	8%
DRB1*0301	47%
DRB1*030101	13%
DRB1*03	100% TOTAL

58 LABS REPORTING DRB3

DRB3*+	28%
DRB3*0101	48%
DRB3*010102	2%
DRB3*01	22%

10 SEROLOGY LABS

DR1	100%
DR3	40%
DR17	50%
DR3	90% TOTAL
DR52	100%

69 LABS REPORTING DQB1

DQB1*03	28%
DQB1*030101/09/19	1%
DQB1*0301/09	7%
DQB1*0301/19	6%
DQB1*0301	55%
DQB1*030101	3%
DQB1*03	100% TOTAL
DQB1*05	20%
DQB1*0501	71%
DQB1*050101	9%
DQB1*05	100% TOTAL

14 LABS REPORTING DQA1

DQA1*01	43%
DQA1*0101	43%
DQA1*010101	14%
DQA1*01	100% TOTAL
DQA1*05	36%
DQA1*0505/08/09	7%
DQA1*0505/08	7%
DQA1*0505/09	14%
DQA1*0501	22%
DQA1*05new	7%
DQA1*0505var	7%
DQA1*05	100% TOTAL

16 LABS REPORTING DPB1

DPB1*0401	81%
DPB1*040101	19%
DPB1*0401	100% TOTAL
DPB1*0402	56%
DPB1*0402/*0602	31%
DPB1*0402/*0602+	13%

DQ3	30%
DQ7	70%
DQ3	100% TOTAL
DQ1	50%
DQ5	50%
DQ1	100% TOTAL

*** 58 TYPING LABS ***

B7	97%	0.991
B27	86%	0.899
B42	69%	0.898
B55	43%	0.932
B81	41%	0.969
B56	34%	0.962
B73	29%	1.000
B13	28%	0.931
B60	28%	0.914
B54	21%	1.000
B67	21%	1.000
B48	17%	0.950
A2	14%	0.960
B40	14%	0.960
B22	12%	1.000
B47	10%	1.000
B82	10%	1.000
B61	9%	1.000
B41	9%	0.737
B57	9%	0.571
B58	7%	0.900
B8	5%	0.941
2708	3%	1.000
7CREG	3%	1.000
A23	3%	1.000
A29	3%	1.000
A66	3%	1.000
A33	3%	0.889
B38	3%	0.857

*** 58 TYPING LABS ***

B7	93%	0.818
B27	76%	0.759
B42	52%	0.892
B60	45%	0.980
B13	36%	0.927
B48	33%	1.000
B81	33%	0.963
B61	31%	0.968
B55	29%	0.906
B67	28%	1.000
B47	22%	1.000
B56	17%	0.882
B40	16%	0.969
B22	9%	1.000
B54	9%	0.778
A66	7%	1.000
A24	5%	1.000
2708	3%	1.000
7CREG	3%	1.000
???	3%	1.000
A23	3%	1.000
B62	3%	1.000
B82	3%	1.000
A32	3%	0.778
B73	3%	0.667
A11	3%	0.636
B58	3%	0.600
B38	3%	0.500

Methods:

- (1) - NIH std
- (2) - NIH ext
- (3) - NIH Amos wash
- (4) - Antiglobulin
- (5) - Elisa
- (6) - Other

*** 58 LABORATORIES REPLIED ***

***** NEXT SHIPMENT: AUG 8 2007 *****

Method: All

***** SERUM NO. 925 ***** SERUM NO. 926 *****

*** 9 TYPING LABS ***

B7	100%	0.986
B27	78%	0.879
B73	33%	1.000
B81	33%	0.800
B42	22%	0.667
2708	11%	1.000
B77	11%	1.000
B38	11%	0.667
B44	11%	0.500
B41	11%	0.250

*** 9 TYPING LABS ***

B7	78%	0.617
B27	56%	0.519
2708	11%	1.000
???	11%	1.000
B81	11%	1.000
B58	11%	0.500
B38	11%	0.333

*** 9 LABORATORIES REPLIED ***

Method: NIH-std

***** SERUM NO. 925 ***** SERUM NO. 926 *****

*** 5 TYPING LABS ***

B7	100%	1.000
B27	100%	0.727
B58	40%	1.000
B42	40%	0.800
B57	40%	0.455
B13	20%	1.000
B73	20%	1.000
B81	20%	1.000
B56	20%	0.500

*** 5 TYPING LABS ***

B7	100%	0.710
B27	100%	0.522
B42	20%	0.200

*** 5 LABORATORIES REPLIED ***

***** NEXT SHIPMENT: AUG 8 2007 *****

Method: NIH-ext

	SERUM NO. 925										SERUM NO. 926										METHOD						
	%	%	B	B	B	B	B	B	B	B	B	%	%	B	B	B	B	B	B	B		B					
	POS	8'S	7	2	7	1	5	7	3	6	0	4	POS	8'S	7	2	7	0	8	7	1	7	3	1			
Burger, Joe	100	100	+	+	+	+	+	+			+		B82, B61, B13	82	100	+	+	+	+	+	+	+	+	+	B55	(L-3)	
Cantwell, Lin	???	???	+	+	+	+	+	+	+	+	+		B82	???	???	+	+	+	+	+	+	+	+	+	B55	(L-3)	
Cohen & Sumy	???	???	+	+	+	+	+	+	+	+	+			???	???	+	+	+	+	+	+	+	+	+		(L-3)	
Cook, Daniel	???	???	+	+	+		+	+	+	+	+		8101, A33, 8201	???	???	+	+		+		+	+	+	+	8101, B55, B45	(F-3)	
Dunn, Paul Ph	95	???	+	+	+		+			+	+	+	B13, B41, B61	62	???	+	+	+		+		+	+	+	B41, B49, B54>	(L-3)	
Eckels/CPMC,	92	???		+	+		+				+		B13, B39, B41>	90	???		+	+	+		+	+	+	+	B49, B54, B55>	(LF-3)	
Ellis, Thomas	95	???	+	+	+								B13, B22, B40, A2>	91	???	+	+	+		+			+	+	B40, B22, A1	(LF-3)	
Fotino, Maril	95	100	+	+	+			+	+				B82, B61	62	100	+	+	+		+	+		+	+		(L-3)	
Gautreaux, Mi	100	???	+	+	+	+	+		+				A2, A23	74	???	+	+	+	+		+	+	+	+		(L-3)	
Gideon, Osna	100	???	+	+	+	+		+					B22, B40, B82>	82	???	+	+	+		+	+	+	+	+	B40, B22	(L-3)	
Hamdi, Nuha D	91	100	+								+		CW1, A33, CW9, A2>	58	100	+	+		+	+		+	+	+	A31, B82, A24>	(L-3)	
Han, Hoon Dr	68	???	+									+	A23, A33, B39>	60	???	+	+		+				+	+	A23, B55, B51	(L-3)	
Harville/ACH	48	100	+	+	+	+	+			+	+	+	A66, B47	28	100	+	+	+	+	+		+	+	+	+	B55, B56, B54	(F-3)
Kamoun, Malek	91	???	+	+	+	+		+	+				B22, B40, B47>	58	???	+	+	+		+	+	+	+	+	+	B40, B22	(L-3)
Klein, Tirza	98	100	+	+		+	+	+	+	+	+	+	B48, B13, B35	78	100	+	+	+	+	+	+	+	+	+	+	B62, B58	(L-3)
MacCann, Eile	96	???	+	+		+	+			+	+		B61, B48	86	???	+	+		+	+			+	+	+	B55, B56	(L-3)
McAlack-Bala	54	100	+	+	+	+	+			+	+		B82	60	100	+	+	+	+	+		+	+	+	+		(L-3)
Moore, S. Brea	62	???	+	+	+	+	+	+	+	+	+		2708	29	???	+	+	+	+	+	+	+	+	+	+	2708, A66	(L-3)
Ozawa, Mikki	???	???	+	+	+	+	+	+	+	+	+	+	B82	???	???	+	+	+	+	+	+	+	+	+	+	6602, B55	(L-3)
Phelan, Donna	???	???	+	+	+	+							A2, A9, B22, B40>	???	???	+	+			+	+	+	+	+	A9, A66, B22, B40	(L-3)	
Rosen-Bronso	99	100	+	+	+	+	+	+	+	+	+	+		84	100	+	+	+	+	+	+	+	+	+	+	A24, B55	(F-3)
Sage, Deborah	100	???	+	+	+		+			+	+		B61, B41, B48>	96	???	+	+	+		+		+	+	+	+	B22, B41, B82>	(L-3)
Satake, Masah	???	???	+	+	+		+			+	+		A32, A2	???	???	+	+	+	+	+	+	+	+	+	+	B55	(L-3)
Smith/Baylor	95	???	+										A2, A23, A24, A68>	53	???	+	+	+	+		+	+	+	+	+	B54, B55, B56	(L-3)
Smith/MI,	95	???	+	+	+	+		+	+				B22, 2708, A10>	64	???	+	+	+		+	+	+	+	+	+	2708, 6602, B40>	(L-3)
Suciu-Foca, N	91	100	+	+	+	+		+	+				8201, B22	49	100	+	+	+	+	+	+	+	+	+	+	A66	(L-3)
Ward, William	87	???	+	+	+		+	+					B22, A10, 8201>	57	???	+	+	+	+	+	+	+	+	+	+	6602, B22, B40	(LF-3)
Yu_Neng/ARC,	16	???	+	+	+	+	+			+	+		B82, 7CREG	22	???	+	+	+		+	+	+	+	+	+	1302, 7CREG	(L-3)
Yu_Neng/UMMM	76	???	+	+	+	+	+	+	+	+	+	+	B82, 7CREG	52	???	+		+	+	+	+	+	+	+	+	A66, 7CREG	(L-3)

(3) - L-Luminex, F-Flow

*** 29 TYPING LABS ***

B7	97%	1.000
B42	90%	1.000
B27	83%	1.000
B81	69%	1.000
B55	62%	1.000
B67	52%	1.000
B56	45%	1.000
B73	45%	1.000
B54	34%	1.000
B60	34%	1.000
B82	31%	1.000
B13	28%	1.000
B22	24%	1.000
B48	24%	1.000
A2	21%	1.000
B47	17%	1.000
B61	17%	1.000
B40	14%	1.000
8201	10%	1.000
A23	10%	1.000
B41	10%	1.000
A33	10%	0.895
2708	7%	1.000
7CREG	7%	1.000
A10	7%	1.000
A68	7%	1.000
B39	7%	1.000
8101	3%	1.000
A9	3%	1.000
A19	3%	1.000
A24	3%	1.000
A25	3%	1.000
A26	3%	1.000
A29	3%	1.000
A32	3%	1.000
A66	3%	1.000
A69	3%	1.000
B8	3%	1.000
B35	3%	1.000
B46	3%	1.000
B57	3%	1.000
B58	3%	1.000
CW9	3%	1.000
CW1	3%	1.000
CW7	3%	0.941

*** 29 TYPING LABS ***

B7	97%	1.000
B42	93%	1.000
B27	90%	0.973
B48	72%	1.000
B60	72%	1.000
B67	66%	1.000
B47	62%	1.000
B81	62%	1.000
B13	52%	0.909
B61	48%	1.000
B55	41%	1.000
B22	24%	1.000
B40	21%	1.000
A66	17%	1.000
B54	14%	1.000
B56	14%	1.000
6602	10%	1.000
2708	7%	1.000
7CREG	7%	1.000
A24	7%	1.000
B41	7%	1.000
B49	7%	1.000
B82	7%	1.000
1302	3%	1.000
8101	3%	1.000
A1	3%	1.000
A9	3%	1.000
A23	3%	1.000
A31	3%	1.000
B45	3%	1.000
B51	3%	1.000
B58	3%	1.000
B62	3%	1.000
A32	3%	0.800

*** 29 LABORATORIES REPLIED ***

***** NEXT SHIPMENT: AUG 8 2007 *****

***** SERUM NO. 925 ***** SERUM NO. 926 *****

	SERUM NO. 925										SERUM NO. 926										METHOD																														
	%	%	B	B	B	B	B	B	B	B	B	%	%	B	B	B	B	B	B	B		B	B																												
	POS	8'S	7	2	7	7	1	6	5	2	3	0	POS	8'S	7	7	2	3	7	1	6	5	4	4																											
Choo, Yoon MD	93	100	+	+	+				+	+					+	+	+							B54, B41	55	0	+	+																	B60, B61	(5)					
Esteves-Kond	93	67	+	+	+					+	+					+	+	+		+	+	+			B73, A2	61	50	+	+	+					+	+	+										B54, B38	(5)			
Hahn, Amy B.	10	???	+	+	+	+				+					+	+	+	+		+	+	+			B40, B46, B48, B8	10	???	+	+	+	+				+	+	+													B40, B46, B48, B8	(5)
Klein, Jon MD	93	???	+	+	+				+	+					+	+	+	+		+	+				B54, A66, A34	73	???	+	+	+	+				+	+	+													B54, B60, B61	(5)
McAlack, Robe	96	100	+	+	+	+				+	+				+	+	+	+		+	+				B46, B47	71	100	+	+	+	+				+	+	+													B40	(5)
Paik, Young K	35	100	+	+	+	+	+	+	+						+	+	+	+		+	+																				B22, B40, B73	(5)									
Suciu-Foca, N	8	100	+		+		+								+	+																									B40	(5)									

***** SERUM NO. 925 ***** SERUM NO. 926 *****

*** 7 TYPING LABS ***

B7	100%	1.000
B42	86%	1.000
B27	71%	1.000
B67	71%	1.000
B13	43%	1.000
B22	43%	1.000
B55	43%	1.000
B56	43%	1.000
B81	43%	0.909
B46	29%	1.000
B54	29%	1.000
B60	29%	1.000
A2	14%	1.000
A34	14%	1.000
A66	14%	1.000
B8	14%	1.000
B40	14%	1.000
B41	14%	1.000
B47	14%	1.000
B48	14%	1.000
B73	14%	1.000

*** 7 TYPING LABS ***

B7	100%	0.882
B27	100%	0.867
B13	71%	1.000
B42	71%	1.000
B67	57%	1.000
B40	43%	1.000
B47	43%	1.000
B48	43%	1.000
B81	43%	1.000
B55	43%	0.875
B56	43%	0.857
B60	29%	1.000
B61	29%	1.000
B54	29%	0.750
B22	14%	1.000
B38	14%	1.000
B73	14%	1.000

*** 7 LABORATORIES REPLIED ***

***** NEXT SHIPMENT: AUG 8 2007 *****

Method: Elisa

	SERUM NO. 927											SERUM NO. 928											METHOD				
	%	%	B	B	B	B	B	B	B	B	B	%	%	B	B	B	B	B	B	B	B						
	POS	8'S	7	7	2	0	1	5	1	3	8	7	7	7	2	5	1	0	7	1	8	6					
Berka, Noured	48	100	+	+	+	+	+	+	+	+			B56, B47	43	100	+	+	+	+	+	+			B47	(4)		
Burger, Joe	100	100	+	+	+	+	+	+	+	+			B47	90	100	+	+	+	+	+	+	+			B13, B47	(3)	
Cantwell, Lin	???	???	+	+	+	+	+	+			+	+	A66, B47	???	???	+	+	+	+	+	+			B73, B54	(3)		
Chongkolwata	16	100	+	+										11	100	+	+									(1)	
Choo, Yoon MD	73	100	+	+	+	+		+	+	+			B41	70	100	+	+	+	+				+		B54, B47, B41	(5)	
Cohen & Sumy	80	???	+	+	+	+		+	+	+				???	???	+	+	+	+		+	+			B13, B54	(3)	
Cook, Daniel	24	60	+	+	+		+							18	100	+	+	+		+						(2)	
Dunckley, Hea	19	92	+	+				+						15	77	+	+									(1)	
Dunk, Arthur	27	100	+	+	+		+	+						23	100	+	+	+	+	+						(6)	
Dunn, Dale Dr	33	100	+	+	+	+	+	+	+				B47	20	100	+	+	+	+							(4)	
Dunn, Paul Ph	24	100	+	+										24	100	+	+									(2)	
Eckels/CPMC,	71	???	+	+	+	+		+	+	+	+		B54, B56	48	???	+	+	+	+		+	+	+	+	B13, B54	(4)	
Ellis, Thomas	94	???	+	+						+	+		B40, B22, B73, A2	75	???	+	+			+					B13, B40, B22>	(3)	
Esteves-Kond	75	50	+	+	+		+	+		+		+	B54, B56, B73	86	100	+	+	+	+	+			+	+	B54, B37, B18	(5)	
Fotino, Maril	23	???	+	+										21	???	+	+									(4)	
Foxcroft, Z.K	17	0	+	+	+								A74, B72, B77	3	25	+		+							B77	(1)	
Gautreaux, Mi	100	???	+	+	+	+	+		+	+	+		B47	94	???	+	+	+	+	+	+		+	+	B47	(3)	
Gideon, Osna	100	???	+	+	+		+			+	+	+	B40, B47, B22	???	???	+	+	+	+		+		+		B40, B22, B13>	(3)	
Graff, Ralph	45	???	+	+	+								B22, B40, B44>	29	???	+	+	+							B40	(4)	
Hahn, Amy B.	64	100	+	+	+								B40, B73, B22>	47	100	+	+	+		+			+		B22, B73	(4)	
Hamdi, Nuha D	82	100					+		+	+			CW1, A24, CW17>	78	100	+		+	+			+			CW1, CW15, A31>	(3)	
Han, Hoon Dr	60	???	+		+	+		+	+		+		A23, B56	58	???	+		+	+	+		+	+	+	A23	(3)	
Harville/ACH	18	100	+	+	+	+	+	+	+		+		B47, B56	25	100	+	+	+	+	+	+	+	+	+	B54	(3)	
Hidajat, Mela	14	100	+										CW2	7	100	+										(1)	
Hogan, Patric	34	100	+	+										25	73	+	+									(1)	
Holdsworth, R	100	???	+	+	+	+	+	+	+				B47, B56	100	???	+	+	+	+	+	+		+	+		()	
Israel, Shosh	20	100	+	+	+		+						B73	15	66	+	+	+	+							(2)	
Kamoun, Malek	85	???	+	+	+					+			B40, B22, B73>	71	???	+	+	+							B13, B40, B13>	(3)	
Klein, Jon MD	80	???	+	+	+	+		+	+	+	+		B54, B56	70	???	+	+	+	+		+	+	+	+		B13, B54	(5)
Klein, Tirza	100	100	+		+	+			+	+	+		B8, B58, B57, B51	94	100	+		+	+	+	+	+	+	+		B40, B58, B51	(3)
Kopko, Patric	28	100	+	+	+		+						2708	20	100	+	+	+	+							2708	(1)
Lardy, N.M. D	33	100	+	+				+						26	90	+	+									(2)	
Lazda, Velta	70	100	+	+	+	+			+	+			A2	30	???	+	+	+	+		+		+	+		(4)	
MacCann, Eile	96	???	+		+	+	+	+	+		+		B56	96	???	+		+	+	+	+		+	+	+	(3)	
Mah, Helen	40	100	+	+	+		+	+	+				8101	33	100	+	+	+	+	+		+	+	+		B54, 8101	(4)
McAlack, Robe	88	100	+	+	+					+	+	+	B40, B22	93	100	+	+	+	+		+		+			B13, B40	(5)
McAlack-Bala	28	100	+	+	+		+							17	50	+	+									A74, B73	(4)
McCluskey, Ja	9	???											???	3	100											???	(6)
Moore, S. Brea	57	???	+	+	+	+		+		+	+		A66, 2708	37	???	+	+	+	+	+		+	+			2708, A66	(3)
Mytilineos, J	26	81	+	+										16	94	+											(1)
Ozawa, Mikki	65	???	+	+	+	+	+	+			+	+	6602, B47	???	???	+	+	+	+	+	+	+		+		6602, B73	(3)
Paik, Young K	65	100	+	+	+					+	+		B73, B22, B40	57	33	+	+	+					+			B13, B73, B22>	(4)
Phelan, Donna	???	???	+	+	+		+				+		B22, B40, B47, A2>	???	???	+	+	+	+							B22, B40, B13>	(3)
Rosen-Bronso	99	100	+	+	+	+	+	+			+		A2, A68, A69	94	100	+	+	+	+	+	+					B44, B45, B54	(3)
Sage, Deborah	100	???	+	+	+	+	+	+	+	+	+		B22, B47	98	???	+	+	+		+	+	+	+			B82, B22, B8	(3)
Satake, Masah	???	???	+	+				+	+	+	+	+	B54	???	???	+	+	+		+	+	+	+	+		B54	(3)
Schroeder, M.	23	???	+	+			+						B41	14	???	+	+	+		+						(4)	
Smith/Baylor	17	???	+		+				+					22	???	+		+	+		+					(4)	
Smith/MI,	33	80	+	+	+	+					+		B54	14	50	+										(4)	
Stewart, Dod	23	100	+	+	+	+							B56	7	100	+										(4)	
Suciu-Foca, N	20	82	+	+	+		+							15	38	+			+							(1)	
Tbakhi, Abdel	28	100	+	+	+					+			B40	24	100	+	+		+							B13, B40	(4)
Turner, E.V.	22	100	+	+	+		+							7	0	+			+							(1)	

*** 58 TYPING LABS ***

B7	97%	0.991
B27	84%	0.952
B42	71%	0.981
B60	48%	0.932
B81	41%	1.000
B55	41%	0.860
B13	40%	0.979
B61	40%	0.923
B48	28%	0.955
B47	24%	1.000
B67	24%	1.000
B40	16%	1.000
B22	16%	0.967
B56	16%	0.933
B73	12%	0.889
A2	10%	0.909
B54	9%	0.875
A66	7%	1.000
2708	3%	1.000
A26	3%	1.000
B51	3%	1.000
B57	3%	1.000
B41	3%	0.800

*** 58 TYPING LABS ***

B7	98%	0.963
B27	76%	0.743
B42	55%	0.913
B55	47%	0.913
B81	40%	0.968
B60	38%	0.959
B48	28%	1.000
B67	28%	1.000
B61	28%	0.933
B56	24%	1.000
B13	21%	1.000
B73	17%	1.000
B54	17%	0.929
B47	16%	1.000
B40	16%	0.960
B22	12%	0.955
A66	5%	1.000
2708	3%	1.000
7CREG	3%	1.000
A32	3%	1.000
B18	3%	1.000
B41	3%	1.000
B44	3%	1.000
B45	3%	1.000

Methods:

- (1) - NIH std
- (2) - NIH ext
- (3) - NIH Amos wash
- (4) - Antiglobulin
- (5) - Elisa
- (6) - Other

*** 58 LABORATORIES REPLIED ***

***** NEXT SHIPMENT: AUG 8 2007 *****

Method: All

***** SERUM NO. 927 ***** SERUM NO. 928 *****

*** 9 TYPING LABS ***

B7	100%	0.984
B27	78%	0.935
B42	44%	1.000
B81	33%	1.000
2708	11%	1.000
A74	11%	1.000
B72	11%	1.000
B77	11%	1.000
CW2	11%	0.750
B55	11%	0.200

*** 9 TYPING LABS ***

B7	100%	0.908
B27	44%	0.391
B81	33%	0.800
2708	11%	1.000
B77	11%	1.000
B42	11%	0.200

*** 9 LABORATORIES REPLIED ***

***** NEXT SHIPMENT: AUG 8 2007 *****

Method: NIH-std

***** SERUM NO. 927 ***** SERUM NO. 928 *****

*** 5 TYPING LABS ***

B7	100%	1.000
B27	100%	0.818
B42	60%	0.778
B55	40%	0.714
B81	20%	1.000
B73	20%	0.500

*** 5 TYPING LABS ***

B7	100%	0.935
B27	100%	0.478
B42	20%	1.000
B81	20%	1.000
B55	20%	0.400

*** 5 LABORATORIES REPLIED ***

***** NEXT SHIPMENT: AUG 8 2007 *****

Method: NIH-ext

	SERUM NO. 927										SERUM NO. 928										METHOD					
	% POS	% 8'S	B 7	B 7	B 4	B 4	B 6	B 4	B 8	B 6	B 6	B 5	% POS	% 8'S	B 7	B 7	B 2	B 7	B 5	B 4		B 8	B 4	B 6	B 6	
Burger, Joe	100	100	+	+	+	+	+	+	+	+	+	B13	90	100	+	+	+	+	+	+	+	+	+	+	B13	(L-3)
Cantwell, Lin	???	???	+	+	+	+	+	+	+	+	+	A66	???	???	+	+	+	+	+	+	+	+	+	+	B73, B54	(L-3)
Cohen & Sumy	80	???	+	+	+	+	+	+	+	+	+	B13	???	???	+	+	+	+	+	+	+	+	+	+	B13, B54	(L-3)
Cook, Daniel	???	???	+	+	+	+	+	+	+	+	+	8101, B73	???	???	+	+	+	+	+	+	+	+	+	+	8101, B56	(F-3)
Dunn, Paul Ph	89	???	+	+	+	+	+	+	+	+	+	B13, B37, B41>	73	???	+	+	+	+	+	+	+	+	+	+	B13, B41, B45>	(L-3)
Eckels/CPMC,	94	???	+	+	+	+	+	+	+	+	+	B13, B39, B41>	75	???	+	+	+	+	+	+	+	+	+	+	B13, B41, B44>	(LF-3)
Ellis, Thomas	94	???	+	+	+	+	+	+	+	+	+	B13, B40, B22, A2>	75	???	+	+	+	+	+	+	+	+	+	+	B13, B40, B22>	(LF-3)
Fotino, Maril	66	100	+	+	+	+	+	+	+	+	+	B13	71	100	+	+	+	+	+	+	+	+	+	+	B82	(L-3)
Gautreaux, Mi	100	???	+	+	+	+	+	+	+	+	+	B13	94	???	+	+	+	+	+	+	+	+	+	+	B40, B22, B13	(L-3)
Gideon, Osna	100	???	+	+	+	+	+	+	+	+	+	B40, B13, B22	???	???	+	+	+	+	+	+	+	+	+	+	B40, B22, B13	(L-3)
Hamdi, Nuha D	82	100	+	+	+	+	+	+	+	+	+	CW1, B13, A24, A2>	78	100	+	+	+	+	+	+	+	+	+	+	CW1, CW15, A31>	(L-3)
Han, Hoon Dr	60	???	+	+	+	+	+	+	+	+	+	A23, B56	58	???	+	+	+	+	+	+	+	+	+	+	A23, B56	(L-3)
Harville/ACH	18	100	+	+	+	+	+	+	+	+	+	B56	25	100	+	+	+	+	+	+	+	+	+	+	B56, B54	(F-3)
Kamoun, Malek	85	???	+	+	+	+	+	+	+	+	+	B40, B13, B22>	71	???	+	+	+	+	+	+	+	+	+	+	B13, B40, B13>	(L-3)
Klein, Tirza	100	100	+	+	+	+	+	+	+	+	+	B8, B13, B58, B57>	94	100	+	+	+	+	+	+	+	+	+	+	B40, B58, B51	(L-3)
MacCann, Eile	96	???	+	+	+	+	+	+	+	+	+	B56	96	???	+	+	+	+	+	+	+	+	+	+	B56	(L-3)
McAlack-Bala	54	100	+	+	+	+	+	+	+	+	+	A66, 2708	62	100	+	+	+	+	+	+	+	+	+	+	2708, A66	(L-3)
Moore, S. Brea	57	???	+	+	+	+	+	+	+	+	+	6602	37	???	+	+	+	+	+	+	+	+	+	+	6602, B73	(L-3)
Ozawa, Mikki	65	???	+	+	+	+	+	+	+	+	+	B22, B40, B13, A2>	???	???	+	+	+	+	+	+	+	+	+	+	B22, B40, B13>	(L-3)
Phelan, Donna	???	???	+	+	+	+	+	+	+	+	+	A2, A68, A69	94	100	+	+	+	+	+	+	+	+	+	+	B44, B45, B54	(F-3)
Rosen-Bronso	99	100	+	+	+	+	+	+	+	+	+	B13, B22	98	???	+	+	+	+	+	+	+	+	+	+	B82, B22, B8	(L-3)
Sage, Deborah	100	???	+	+	+	+	+	+	+	+	+	B54, B13	???	???	+	+	+	+	+	+	+	+	+	+	B54, B56	(L-3)
Satake, Masah	???	???	+	+	+	+	+	+	+	+	+	B8, B13, B41, B54	71	???	+	+	+	+	+	+	+	+	+	+	B8, B13, B41, B54	(L-3)
Smith/Baylor	84	???	+	+	+	+	+	+	+	+	+	2708, 6602, B22	60	???	+	+	+	+	+	+	+	+	+	+	2708, B22, B73>	(L-3)
Smith/MI,	62	???	+	+	+	+	+	+	+	+	+	A66	65	100	+	+	+	+	+	+	+	+	+	+	B56, 8201, B73	(L-3)
Suciu-Foca, N	85	100	+	+	+	+	+	+	+	+	+	A66, B22, B40>	78	???	+	+	+	+	+	+	+	+	+	+	B22, 6602, B73>	(LF-3)
Ward, William	87	???	+	+	+	+	+	+	+	+	+	B73, 7CREG	21	???	+	+	+	+	+	+	+	+	+	+	B56, B73, 7CREG	(L-3)
Yu_Neng/ARC,	21	???	+	+	+	+	+	+	+	+	+	A66	56	???	+	+	+	+	+	+	+	+	+	+	A66, 7CREG	(L-3)
Yu_Neng/UMMM	58	???	+	+	+	+	+	+	+	+	+				+	+	+	+	+	+	+	+	+	+		

(3) - L-Luminex, F-Flow

*** 29 TYPING LABS ***

B7	93%	1.000
B27	90%	1.000
B42	86%	1.000
B47	66%	1.000
B48	62%	1.000
B60	62%	1.000
B81	59%	1.000
B61	55%	1.000
B67	55%	1.000
B13	48%	1.000
B55	48%	1.000
B22	24%	1.000
A66	17%	1.000
B40	17%	1.000
B56	17%	1.000
B73	17%	1.000
B54	14%	1.000
A2	14%	0.923
B41	10%	1.000
2708	7%	1.000
6602	7%	1.000
B8	7%	1.000
7CREG	3%	1.000
8101	3%	1.000
A23	3%	1.000
A26	3%	1.000
A28	3%	1.000
A33	3%	1.000
A68	3%	1.000
A69	3%	1.000
B37	3%	1.000
B39	3%	1.000
B51	3%	1.000
B57	3%	1.000
B58	3%	1.000
CW17	3%	1.000
CW1	3%	1.000
A24	3%	0.833
CW9	3%	0.800

*** 29 TYPING LABS ***

B7	97%	1.000
B27	90%	1.000
B42	86%	1.000
B55	66%	1.000
B67	66%	1.000
B48	62%	1.000
B81	55%	1.000
B47	45%	1.000
B60	41%	1.000
B61	41%	1.000
B13	34%	1.000
B73	31%	1.000
B54	28%	1.000
B22	24%	1.000
B56	24%	1.000
B40	21%	1.000
B41	14%	1.000
6602	10%	1.000
A66	10%	1.000
B45	10%	1.000
2708	7%	1.000
7CREG	7%	1.000
A32	7%	1.000
B8	7%	1.000
B44	7%	1.000
B82	7%	1.000
8101	3%	1.000
8201	3%	1.000
A23	3%	1.000
A31	3%	1.000
B46	3%	1.000
B51	3%	1.000
B53	3%	1.000
B58	3%	1.000
CW15	3%	1.000
CW1	3%	1.000

Methods:

- (1) - NIH std
- (2) - NIH ext
- (3) - NIH Amos wash
- (4) - Antiglobulin
- (5) - Elisa
- (6) - Other

*** 29 LABORATORIES REPLIED ***

***** NEXT SHIPMENT: AUG 8 2007 *****

Method: Luminex/Flow

***** SERUM NO. 927 ***** SERUM NO. 928 *****

	SERUM NO. 927										SERUM NO. 928										METHOD					
	%	%	B	B	B	B	B	B	B	B	%	%	B	B	B	B	B	B	B	B						
	POS	8'S	7	7	2	0	3	1	5	1	0	8	POS	8'S	7	7	2	0	5	1	1	6	3	8		
Berka,Noured	48	100	+	+	+	+	+	+	+	+			B56,B47	43	100	+	+	+	+	+	+	+	+		B47	(4)
Dunn,Dale Dr	33	100	+	+	+	+		+	+	+			B47	20	100	+	+	+			+					(4)
Eckels/CPMC,	71	???	+	+	+	+	+	+	+		+		B54,B56	48	???	+	+	+	+	+		+	+		B13,B54	(4)
Fotino,Maril	23	???	+	+										21	???	+	+									(4)
Graff,Ralph	45	???	+	+	+		+				+		B22,B44,A26	29	???	+	+	+							B40	(4)
Hahn,Amy B.	64	100	+	+	+		+				+		B73,B22,B37	47	100	+	+	+	+				+	+	B22	(4)
Lazda,Velta	70	100	+	+	+	+	+	+					A2	30	???	+	+	+	+	+		+	+			(4)
Mah,Helen	40	100	+	+		+		+	+				8101	33	100	+	+		+	+		+	+		B54,8101	(4)
McAlack-Bala	28	100	+	+	+				+					17	50	+	+						+		A74	(4)
Paik,Young K	65	100	+	+	+		+			+	+		B73,B22	57	33	+	+	+					+	+	B13,B22,B40	(4)
Schroeder,M.	23	???	+	+						+			B41	14	???	+	+		+							(4)
Smith/Baylor	17	???	+			+		+						22	???	+		+	+	+						(4)
Smith/MI,	33	80	+	+	+	+					+		B54	14	50	+										(4)
Stewart,Dod	23	100	+	+	+	+							B56	7	100	+										(4)
Suciu-Foca,N	50	56	+	+	+		+			+	+	+	B22	20	55	+	+	+			+					(4)
Tbakhi,Abdel	28	100	+	+		+	+				+			24	100	+	+		+						B13,B40	(4)
Ward,William	47	100	+	+	+	+	+	+	+				A66	13	67	+					+					(4)

***** SERUM NO. 927 ***** SERUM NO. 928 *****

*** 17 TYPING LABS ***

B7	100%	1.000
B27	94%	1.000
B42	71%	1.000
B60	59%	0.867
B13	53%	0.958
B61	41%	0.800
B55	35%	0.923
B40	29%	1.000
B81	29%	1.000
B22	24%	0.947
B48	24%	0.875
B56	18%	1.000
B47	12%	1.000
B73	12%	1.000
B54	12%	0.667
8101	6%	1.000
A26	6%	1.000
A66	6%	1.000
B37	6%	1.000
B44	6%	1.000
A2	6%	0.882
B41	6%	0.667

*** 17 TYPING LABS ***

B7	100%	1.000
B27	76%	0.906
B42	53%	0.923
B60	47%	0.923
B55	29%	1.000
B56	24%	1.000
B81	24%	1.000
B61	24%	0.818
B13	18%	1.000
B48	18%	1.000
B73	18%	1.000
B40	18%	0.929
B22	12%	0.941
B54	12%	0.667
8101	6%	1.000
A74	6%	1.000
B47	6%	1.000

*** 17 LABORATORIES REPLIED ***

***** NEXT SHIPMENT: AUG 8 2007 *****

Method: Antiglobulin

***** SERUM NO. 927 ***** SERUM NO. 928 *****

	SERUM NO. 927										SERUM NO. 928										METHOD					
	%	%	B	B	B	B	B	B	B	B	B	%	%	B	B	B	B	B	B	B		B	B			
	POS	8'S	7	2	7	3	7	5	6	8	0	1	POS	8'S	7	7	2	6	5	7	1	4	8	7		
Choo, Yoon MD	73	100	+	+	+	+		+					B60, B61, B41	70	100	+	+	+	+	+		+	+		B41	(5)
Esteves-Kond	75	50	+	+	+	+	+	+	+			+	B54, B73	86	100	+	+	+	+	+		+	+	+	B37, B18	(5)
Hahn, Amy B.	18	???	+	+	+	+	+				+	+	B22, B47	14	???	+	+	+	+	+	+			+	B40, B13	(5)
Klein, Jon MD	80	???	+	+	+	+	+	+	+				B54, B60, B61	70	???	+	+	+	+	+		+			B13, B60, B61	(5)
McAlack, Robe	88	100	+	+	+	+	+				+	+	B22	93	100	+	+	+	+	+	+				B13, B40	(5)
Paik, Young K	21	100	+	+	+	+	+	+	+	+	+		B47	75	100	+	+	+			+		+	+	B8, B22, B40, B41	(5)
Suciu-Foca, N	8	100	+											11	100	+	+					+	+	+	B60, B61	(5)

***** SERUM NO. 927 ***** SERUM NO. 928 *****

*** 7 TYPING LABS ***

B7	100%	0.933
B13	86%	1.000
B27	86%	1.000
B42	86%	1.000
B67	71%	1.000
B55	57%	1.000
B40	43%	1.000
B48	43%	1.000
B56	43%	0.857
B22	29%	1.000
B47	29%	1.000
B54	29%	1.000
B60	29%	1.000
B61	29%	1.000
B81	29%	1.000
B41	14%	1.000
B73	14%	1.000

*** 7 TYPING LABS ***

B7	100%	1.000
B27	100%	1.000
B42	86%	1.000
B55	71%	1.000
B56	71%	1.000
B67	57%	1.000
B13	43%	1.000
B40	43%	1.000
B47	43%	1.000
B54	43%	1.000
B48	43%	0.923
B81	43%	0.909
B41	29%	1.000
B60	29%	1.000
B61	29%	0.917
B8	14%	1.000
B18	14%	1.000
B22	14%	1.000
B37	14%	1.000

*** 7 LABORATORIES REPLIED ***

***** NEXT SHIPMENT: AUG 8 2007 *****

Method: Elisa

INVESTIGATOR		DNA EXTRACT #389							method
CTR	NAME	A1	A2	B1	B2	C1	C2		
5488	Adams, Sharon	*020101	*1115	*27	*35	*020202	*040101/09N	SBT, SSP, RSSO	
2300	Allegheny Ge	*02	*11	*27	*35	*02	*04	SSP	
745	Anthony Nola	*0201	*1115/28	*2705	*3501	*020202	*040101	SSO, SSP, RSCA+	
2020	Barnardo, Mar	*0201/43N/66/75+	*1115	*2705/13	*3501/40N/42/57	*020202	*0401/09N	SSP, SBT	
4345	Blasczyk, Rai	*0201/01L/09/43N+	*1115	*2705/13	*3501/40N/42/57	*0202	*0401/09N	PCR-SBT	
5106	Brown, Colin	*0201	*1115	*2705/13	*3501/40N/42/57	*0202/04/08/09	*0401/05/09N/12	PCR-RSSOP, SBT	
785	Chan, Soh Ha	*02	*1115	*2705/13	*3501/40N/42/53N+	*0202/13	*0401/09N	SBT	
3224	Chen, Dongfen	*0201	*1115	*2705/13	*3501/42/57	*0202	*0401/09N	SBT, SSO	
3966	Chongolwatan	*0201	*1104	*27	*35	*0202	*0401	PCR-SSP	
16	Cook, Daniel	*020101/83N	*1115	*2705/13	*350101/42/57	*020202	*040101/09N	RSSOP, SSP, SBT	
3625	Darke, Christ	*02	*11	*2705/10/13	*35	*0202/08	*0401	PCR-SSP	
1108	Davis, Mary	*0201	*1115	*2705	*3501	*0202	*0401	SSO, SSP	
5891	Du, Keming	*0201/07/09	*1104	*2703/05	*3501/07			PCR-SSO	
3186	Dunckley, Hea	*02	*11	*27	*35	*02	*04	SSP	
3766	Dunn, Paul	*02	*1104/15	*2703/05/13/17	*35	*02	*04	SSO	
3428	Eckels/Utah	*0201/83N	*1115	*2705/08/13	*3501/42/57/*5303	*0202	*0401/09N	SBT	
4251	Ellis, Thomas	*0201	*1115	*2705/13	*3501/42/57	*0202	*0401/09N	PCR-SSO, SEQ	
762	Fischer&Mayr	*0201/09	*1115	*2705	*3501/40N	*0202	*0401/09N	SBTex1-3, RSSO	
729	Fotino, Maril	*0201	*1115	*2705	*3501/15	*0202/08	*0401	SSOP, SSP	
810	Hamdi, Nuha	*02010102L	*1104	*2703	*350102	*0207		SSO	
1461	Hidajat, Mela	*0201	*1115/28	*2705	*3501	*0202/15	*0401	SSO, SSP	
615	Holdsworth, R	*0201/09/43N/66+	*1115	*2705/13	*3501/40N/42/57	*0202	*0401/09N	SBT	
2344	Hurley&Hartz	*02010101/010102L+	*1115	*270502/0504/13	*350101/0103/40N+	*020202	*04010101/010102+	SBT	
3261	Iwaki, Yui	*0201	*1114/16	*2705	*3501	*0202/10	*0401	SSP	
797	Kato, Shunich	*0201/01L	*1115	*2705	*3501/42	*0202	*0401/09N	SSO, SBT	
87	Land, Geoff	*0201	*1115/13	*2705	*3501	*0202	*0401	SBT, SSP	
278	Lee, Jar-How	*0201/0102L/66/67+	*1115	*2705	*3501	*0202/09/11/15	*0401/18-20	SSP, RVSSOP	
640	Lee, Kyung Wh	*0201/09/43N/66	*1115	*2705/13	*3501/40N/42	*0202	*0401/09N	PCR-SBT	
9916	McIntyre, Joh	*02010101	*1115	*2705	*350101	*0202/13/15	*0401/19-21/24-26	SBT, SSP, SSO	
8021	Montague, Bri	*020101-0104/0106+	*1104	*2701/02/05+	*3501-0401/06-09+	*0202/04-14	*0401/03-10+	PCR-SSP	
5323	Murad, Shahna	*02	*11	*27	*35	*02	*04	PCR-SSP	
5107	Noche, Olivia	*02010101-0112/88N+	*1113/15	*270502-0508	*350101-0103/0105+	*020201-0205/15	*04010101-0104+		
8022	Olerup, Olle	*0201	*1115	*2705	*3501	*0202	*0401	SSP	
8000	Pahl, Armin	*02	*11	*27	*35			SSO	
5096	Park, Jong-Su	*02	*11	*27	*35			RVSSOP	
794	Partanen, Juk	*0201	*1115	*2705	*3501	*0202	*0401	SBT, SSP, SSO	
3648	Pereira, Noem	*02	*11	*27	*35	*02	*04	RVPCR-SSO	
2400	Phelan, Donna	*0201	*11	*2705	*3527	*0202	*0401	RVSSO, SSP	
4689	Rajczyk&Gyodi	*02	*11	*27	*35	*0202/07/09/11	*04	PCR-SSP, SSO	
3753	Reed, Elaine	*0201	*1115	*2705	*3501	*0202	*0401/09N	SBT, SSP	
782	Richard, Luc	*02	*11	*27	*35	*02	*04	SSP	
1694	Sauer, Norber	*02	*11	*27	*35	*02	*04	SSP	
3545	Scornik, Juan	*0201	*1115	*2705	*3501	*0202	*0401	SSOP, SBT	
8042	Shainberg, Br	*02	*11	*27	*35	*02	*04		
5133	Smith/Baylor	*02	*1104/15	*27	*35	*02	*04	SSO	
746	Stamm, Luz	*0201	*1115/28	*2705	*3501	*0202	*0401	RVSSOP, SSP	
13	Tagliere, Jac	*0201	*1115	*2705	*3501	*0202	*040101	SSP	
4021	Trachtenberg	*02	*1104	*2705	*35	*02	*04	RVSSO	
5462	Turner, E.V.	*0201	*1113/15	*2705	*3501	*0202	*0401	SSP	
3135	Wernet, Peter	*0201/01L	*1115	*2705/13	*3501/42	*0202	*0401/09N	SBT, PCR-SSO	

INVESTIGATOR		DNA EXTRACT #390						method
CTR	NAME	A1	A2	B1	B2	C1	C2	
5488	Adams, Sharon	*110101	*260101	*35	*38	*040101/09N	*120301	SBT, SSP, RSSO
2300	Allegheny Ge	*11	*26	*35	*38	*04	*12	SSP
745	Anthony Nola	*1101	*2601/32	*3501	*3801	*040101	*120301	SSO, SSP, RSCA+
2020	Barnardo, Mar	*1101/21N	*2601/24/26	*3541	*380101	*0401/09N	*120301	SSP, SBT
4345	Blasczyk, Rai	*1101/21N	*2601/24/26	*3541	*3801	*0401/09N	*1203	PCR-SBT
5106	Brown, Colin	*11	*26	*3541	*3801	*04	*1203/06/07/12/13	PCR-RSSOP, SBT
785	Chan, Soh Ha	*1101/19/21N	*2601/13/24/26	*3541	*380101	*0401/09N/21	*120301	SBT
3224	Chen, Dongfen	*1101	*2601	*3541	*3801	*0401/09N	*1203	SBT, SSO
3966	Chongolwatan	*1101	*26	*35	*3801	*0401	*1203	PCR-SSP
16	Cook, Daniel	*110101	*260101	*3541	*380101	*040101/09N	*120301	RSSOP, SSP, SBT
3625	Darke, Christ	*1108/12	*26	*35	*38	*0401	*1203	PCR-SSP
1108	Davis, Mary	*1101	*2601	*3541	*3801	*0401	*1203	SSO, SSP
5891	Du, Keming	*1101-03/08	*2601/02/10	*3501/07	*3801/09/10			PCR-SSO
3186	Dunckley, Hea	*11	*26	*35	*38	*04	*12	SSP
3766	Dunn, Paul	*11	*26	*35	*3801/09	*0401/05/07/09N	*1203/06/13	SSO
3428	Eckels/Utah	*1101/19	*2601/13	*3541	*3801	*0401/09N	*1203	SBT
4251	Ellis, Thomas	*1101	*2601	*3541	*3801	*0401/09N	*1203	PCR-SSO, SEQ
762	Fischer&Mayr	*1101	*2601	*3541	*3801	*0401/09N	*1203	SBTex1-3, RSSO
729	Fotino, Maril	*1101/10	*2601	*3541	*3801	*0401	*1203	SSOP, SSP
810	Hamdi, Nuha	*110101	*260101	*3503		*04010101	*0403	SSO
1461	Hidajat, Mela	*1101	*2601	*3541	*3801/12	*0401	*1203	SSO, SSP
615	Holdsworth, R	*1101/21N	*2601/24/26	*3541	*3801	*0401/09N	*1203	SBT
2344	Hurley&Hartz	*110101	*260101/24/26	*3541	*380101	*04010101/010102+	*120301	SBT
3261	Iwaki, Yui	*1101	*2601	*3501/41	*3801	*0401	*1203	SSP
797	Kato, Shunich	*1101	*2601	*3541	*3801	*0401/09N	*1203	SSO, SBT
87	Land, Geoff	*1101	*2601	*3541	*3801	*0401	*1203	SBT, SSP
278	Lee, Jar-How	*1101/21N/22	*2601/23-26	*3541	*3801/09	*0401/18-20	*1203	SSP, RVSSOP
640	Lee, Kyung Wh	*1101/19/21N	*2601/13/24-26	*3541	*3801	*0401/09N	*1203	PCR-SBT
9916	McIntyre, Joh	*110101	*260101	*3541	*380101	*0401/19-21/24+	*1203	SBT, SSP, SSO
8021	Montague, Bri	*1101/02/05-07+	*260101/0103-02+	*3501-0401/06+	*3801/02/04/08+	*0401/03-10+	*120301/0303/0304+	PCR-SSP
5323	Murad, Shahna	*11	*26	*35	*38	*04	*12	PCR-SSP
5107	Noche, Olivia	*110101-0106/24+	*260101/0103+	*3541	*380101/0102/13	*04010101-0104+	*12030101-0303	
8022	Olerup, Ollie	*1101	*2601	*3541	*3801	*0401	*1203	SSP
8000	Pahl, Armin	*11	*26	*35	*38			SSO
5096	Park, Jong-Su	*11	*26	*35	*38			RVSSOP
794	Partanen, Juk	*1101	*2601	*3541	*3801	*0401	*1203	SBT, SSP, SSO
3648	Pereira, Noem	*11	*26	*35	*38	*04	*12	RVPCR-SSO
2400	Phelan, Donna	*1101	*2601	*3541	*3801	*0401	*1203	RVSSO, SSP
4689	Rajczy&Gyodi	*11	*26	*35	*3801/09/12/14	*0401/04/05/08+	*1203/06/13/15	PCR-SSP, SSO
3753	Reed, Elaine	*1101/19	*2601/13	*3541	*3801	*0401/09N	*1203	SBT, SSP
782	Richard, Luc	*11	*26	*35	*38	*04	*12	SSP
1694	Sauer, Norber	*11	*26	*35	*38	*04	*12	SSP
3545	Scornik, Juan	*1101	*2601	*3541	*3801	*0401	*1203	SSOP, SBT
8042	Shainberg, Br	*11	*26	*35	*38	*04	*06	
5133	Smith/Baylor	*11	*26	*35	*3801/09	*04	*1203/06/13	SSO
746	Stamm, Luz	*1101	*2601	*3541	*3801	*0401	*1203	RVSSOP, SSP
13	Tagliere, Jac	*1101	*2601	*3541	*3801	*040101	*1203	SSP
4021	Trachtenberg	*11	*26	*35	*38	*04	*12	RVSSO
5462	Turner, E.V.	*1101	*2601	*3541	*3801	*0401	*1203	SSP
3135	Wernet, Peter	*1101	*2601	*3541	*3801	*0401/09N	*1203	SBT, PCR-SSO

INVESTIGATOR	DNA EXTRACT #391	A2	B1	B2	C1	C2	method
CTR NAME	A1						
5488 Adams, Sharon	*030101	*680201	*4702	*530101	*040101/09N	*060201	SBT, SSP, RSSO
2300 Allegheny Ge	NT						
745 Anthony Nola	*0301	*6802	*4702	*530101	*040101	*060201	SSO, SSP, RSCA+
2020 Barnardo, Mar	*0301/20/21N	*6802	*4702	*530101	*0401/09N/10	*0602	SSP, SBT
4345 Blasczyk, Rai	*0301/01N/20/21N	*6802	*4702	*5301	*0401/09N	*0602	PCR-SBT
5106 Brown, Colin	*03	*6802/18N/27	*4702	*5301/05/08/10	*0401/05/08/09N+	*0602/07/10	PCR-RSSOP, SBT
785 Chan, Soh Ha	*0301/03N/20/21N	*6802	*4702	*530101	*0401/09N	*0602	SBT
3224 Chen, Dongfen	*0301	*6802	*4702	*5301	*0401/09N	*0602	SBT, SSO
3966 Chongolwatan	*03	*68	*4702	*53	*0401	*1801/02	PCR-SSP
16 Cook, Daniel	*030101	*680201	*4702	*530101	*040101/09N	*060201	RSSOP, SSP, SBT
3625 Darke, Christ	*03	*68	*4702/03	*53	*0401	*0602/06	PCR-SSP
1108 Davis, Mary	*0301	*6802	*4702	*5301	*0401	*0602	SSO, SSP
5891 Du, Keming	*0301/03N/04	*6802/18N	*4702	*5301/05/08			PCR-SSO
3186 Dunckley, Hea	*03	*68	*4702	*53	*04	*06	SSP
3766 Dunn, Paul	*03	*6802/18N	*4702	*5301/10	*0401/05/07/09N+	*0602/10/12/13	SSO
3428 Eckels/Utah	*0301	*6802	*4702	*5301	*0401/09N	*0602	SBT
4251 Ellis, Thomas	*0301	*6802	*4702	*5301	*0401/09N	*0602	PCR-SSO, SEQ
762 Fischer&Mayr	*0301	*6802	*4702	*5301	*0401/09N	*0602	SBTex1-3, RSSO
729 Fotino, Maril	*0301	*6802	*4702	*5301	*0401/02	*0602	SSOP, SSP
810 Hamdi, Nuha	*03010101	*6818N	*4702	*530101	*0403		SSO
1461 Hidajat, Mela	*0301	*6802	*4702	*5301	*0401	*0602	SSO, SSP
615 Holdsworth, R	*0301/01N/20/21N+	*6802	*4702	*5301	*0401/09N	*0602	SBT
2344 Hurley&Hartz	*03010101/010102N+	*68020101/020102	*4702	*530101	*04010101/010102+	*06020101/020102	SBT
3261 Iwaki, Yui	*0301	*6802	*4701/02	*5301	*0401	*0602	SSP
797 Kato, Shunich	*0301/01N	*6802	*4702	*5301	*0401/09N	*0602	SSO, SBT
87 Land, Geoff	*0301	*6802	*4702	*5301	*0401	*0602	SBT, SSP
278 Lee, Jar-How	*0301/13/14/20/21N	*6802	*4702	*5301	*0401/18-20	*0602/10/12/13	SSP, RVSSOP
640 Lee, Kyung Wh	*0301/03N/20	*6802/18N	*4702	*5301	*0401/09N	*0602	PCR-SBT
9916 McIntyre, Joh	*0301	*6802	*4702	*530101	*0401/20/24-26	*0602/15/16N	SBT, SSP, SSO
8021 Montague, Bri	*0301-08+	*6801/02/06+	*4701-05	*5301/02/04+	*0401/03-10+	*0602/03/07+	PCR-SSP
5323 Murad, Shahna	*03	*68	*47	*53	*04	*06	PCR-SSP
5107 Noche, Olivia	*030101/010103+	*68020101/020102+	*4702	*530101-0104	*04010101-0104+	*06020101/020102	
8022 Olerup, Olle	*0301	*6802	*4702	*5301	*0401	*0602	SSP
8000 Pahl, Armin	*03	*68	*47	*53			SSO
5096 Park, Jong-Su	*03	*68	*47	*53			RVSSOP
794 Partanen, Juk	*0301	*6802	*4702	*5301	*0401	*0602	SBT, SSP, SSO
3648 Pereira, Noem	*03	*68	*47	*53	*04	*06	RVPCR-SSO
2400 Phelan, Donna	*0301	*6802	*4702	*5301	*0401	*0602	RVSSO, SSP
4689 Rajczy&Gyodi	*03	*6802/18N/34/23	*4702	*5301/10	*0401/04/05/08+	*06	PCR-SSP, SSO
3753 Reed, Elaine	*0301	*6802	*4702	*5301	*0401/09N	*0602	SBT, SSP
782 Richard, Luc	*03	*68	*47	*53	*04	*06	SSP
1694 Sauer, Norber	*03	*68	*47	*53	*04	*06	SSP
3545 Scornik, Juan	*0301	*6802	*4702	*5301	*0401	*0602	SSOP, SBT
8042 Shainberg, Br	*03	*68	*47	*53	*04	*06	
5133 Smith/Baylor	*03	*6802/18N	*4702	*5301/10	*04	*06	SSO
746 Stamm, Luz	*0301	*6802	*4702	*5301	*0401	*0602	RVSSOP, SSP
13 Tagliere, Jac	*030101	*6802	*4702	*5301	*040101	*0602	SSP
4021 Trachtenberg	*03	*68	*4702	*53	*04	*06	RVSSO
5462 Turner, E.V.	*0301	*6802	*4702	*5301/02/05/08/10	*04	*06	SSP
3135 Wernet, Peter	*0301/01N	*6802	*4702	*5301	*0401/09N	*0602	SBT, PCR-SSO

INVESTIGATOR		DNA EXTRACT #392 (Japanese/Black)						method
CTR	NAME	A1	A2	B1	B2	C1	C2	
5488	Adams, Sharon	*240201/07	*680201/31	*4703	*520101/07	*07	*12	SBT, SSP, RSSO
2300	Allegheny Ge	NT						
745	Anthony Nola	*2402	*6802	*4703	*520101	*0718	*1202	SSO, SSP, RSCA+
2020	Barnardo, Mar	*2402/11N/40N	*6802	*4703	*520101/07	*0701/06/18	*1202	SSP, SBT
4345	Blasczyk, Rai	*2402/02L/09N/11N+	*6802	*4703	*5201/07	*0701/06/18	*1202	PCR-SBT
5106	Brown, Colin	*24	*6802/18N/27	*4703	*5201/04/05/07	*07	*1202/08/11/14	PCR-RSSOP, SBT
785	Chan, Soh Ha	*24	*6802/31	*4703	*5201/07	*0701/06/18/22+	*1202/08/18	SBT
3224	Chen, Dongfen	*2402	*6802	*4703	*5201/07	*0701/06/18	*1202	SBT, SSO
3966	Chongolwatan	*24	*68	*47	*5201	*0701/06	*1202	PCR-SSP
16	Cook, Daniel	*240201	*680201	*4703	*520101/07	*0701/18// *0727	*1202// *1208	RSSOP, SSP, SBT
3625	Darke, Christ	*24	*68	*4703	*52	*0718	*1202	PCR-SSP
1108	Davis, Mary	*2402	*6802	*4703	*5201	*0718	*1202	SSO, SSP
5891	Du, Keming	*2402/09N/11N	*6802/18N	*4703	*5201/04/05			PCR-SSO
3186	Dunckley, Hea	*24	*68	*47	*52	*07	*12	SSP
3766	Dunn, Paul	*24	*6802/18N	*4703	*5201/07	*07	*1202/08/16	SSO
3428	Eckels/Utah	*2402/07	*6802/31	*4703	*5201/07	*0701/06/18/22+	*1202/08/18	sbt
4251	Ellis, Thomas	*2402	*6802	*4703	*5201/07	*0701/06/18	*1202	PCR-SSO, SEQ
762	Fischer&Mayr	*2402	*6802	*4703	*5201/07	*0701/06	*1202	SBTex1-3, RSSO
729	Fotino, Maril	*2402	*6802	*4703	*5201/08	*0718	*1202	SSOP, SSP
810	Hamdi, Nuha	*24020101	*6818N	*4703	*520101	*07020101	*0703	SSO
1461	Hidajat, Mela	*2402	*6802	*4703	*5201/08/var	*0701/18	*1202	SSO, SSP
615	Holdsworth, R	*2402/09N/11N/40N+	*6802	*4703	*5201/07	*0701/06/18	*1202	SBT
2344	Hurley&Hartz	*24020101/020102L+	*68020101/020102	*4703	*520101/07	*070101/0102/06+	*120201/0202	SBT
3261	Iwaki, Yui	*2402	*6802	*4701	*5201	*0718	*1202	SSP
797	Kato, Shunich	*2402	*6802	*4703	*5201	*0701/06/18+	*1202/08	SSO, SBT
87	Land, Geoff	*2402// *2449	*6802// *6827	*4702// *4703	*5201	*0718	*1202	SBT, SSP
278	Lee, Jar-How	*2402/58/59/63	*6802/34	*4703	*5201/07	*0701/18/21/24+	*1202	SSP, RVSSOP
640	Lee, Kyung Wh	*2402/09N/11N/40N	*6802/18N	*4703	*5201	*0701/06/18/27	*1202/08	PCR-SBT
9916	McIntyre, Joh	*24020101	*680201	*4703	*5201/07	*0718	*1202	SBT, SSP, SSO
8021	Montague, Bri	*2402/03/07+	*6801/02/06+	*4701-05	*5201/03-05+	*0701/06/07+	*1202/08/10+	PCR-SSP
5323	Murad, Shahna	*24	*68	*47	*52	*07	*12	PCR-SSP
5107	Noche, Olivia	*24020101-0213+	*68020101/020102+	*4702	*520101-0104	*0718	*120201-0203	
8022	Olerup, Olle	*2402	*6802	*4703	*5201	*0718	*1202	SSP
8000	Pahl, Armin	*24	*68	*47	*52			SSO
5096	Park, Jong-Su	*24	*68	*47	*52			RVSSOP
794	Partanen, Juk	*2402	*6802	*4703	*5201/07	*0718	*1202	SBT, SSP, SSO
3648	Pereira, Noem	*24	*68	*47	*52	*07	*12	RVPCR-SSO
2400	Phelan, Donna	*2402	*6802	*4703	*5201	*0718	*1202	RVSSO, SSP
4689	Rajczyk&Gyodi	*24	*6802/18N/31/34	*4701/03	*5201/05/07	*07	*1202	PCR-SSP, SSO
3753	Reed, Elaine	*2402/07	*6802/31	*4703	*5201/07	*0701/06/18/22+	*1202/08/18	SBT, SSP
782	Richard, Luc	*24	*68	*47	*52	*07	*12	SSP
1694	Sauer, Norber	*24	*68	*47	*52	*07	*12	SSP
3545	Scornik, Juan	*2402	*6802	*4703	*5201	*0701	*1202	SSOP, SBT
8042	Shainberg, Br	*24	*68	*47	*52	*07	*12	
5133	Smith/Baylor	*24	*6802/18N	*4703	*5201/07	*07	*12	SSO
746	Stamm, Luz	*2402	*6802	*4703	*5201	*0701/18	*1202	RVSSOP, SSP
13	Tagliere, Jac	*2402	*6802	*4703	*5201	*0718	*1202	SSP
4021	Trachtenberg	*24	*68	*4703	*52	*07	*12	RVSSO
5462	Turner, E.V.	*2402/49	*6802/27	*4702	*5201	*0718	*1202	SSP
3135	Wernet, Peter	*2402	*6802	*4703	*5201/07	*0701/06/18	*1202	SBT, PCR-SSO

SUMMARY

<p>Extract 389 <u>50 labs</u></p> <p>A*02 54%</p> <p>A*0201 40%</p> <p>A*020101 2%</p> <p>A*02010101 2%</p> <p>A*02010102I 2%</p> <p>A*02 100% TOTAL</p> <p>A*11 42%</p> <p>A*1104 10%</p> <p>A*1115 48%</p> <p>A*11 100% TOTAL</p> <p><u>50 labs</u></p> <p>B*27 36%</p> <p>B*2705/13 22%</p> <p>B*2703 2%</p> <p>B*2705 40%</p> <p>B*27 100% TOTAL</p> <p>B*35 66%</p> <p>B*3501 26%</p> <p>B*350101 2%</p> <p>B*350102 2%</p> <p>B*3527 2%</p> <p>B*35 98% TOTAL</p> <p><u>47 labs</u></p> <p>Cw*02 45%</p> <p>Cw*0202 42%</p> <p>Cw*020202 11%</p> <p>Cw*0207 2%</p> <p>Cw*02 100% TOTAL</p> <p>Cw*04 34%</p> <p>Cw*0401/09N 26%</p> <p>Cw*040101/09N 6%</p> <p>Cw*0401 28%</p> <p>Cw*040101 4%</p> <p>Cw*04010101 2%</p> <p>Cw*04 100% TOTAL</p> <p>Cw*12 26%</p> <p>Cw*1203 57%</p> <p>Cw*120301 13%</p> <p>Cw*12 96% TOTAL</p>	<p>Extract 390 <u>50 labs</u></p> <p>A*11 54%</p> <p>A*1101 36%</p> <p>A*110101 10%</p> <p>A*11 100% TOTAL</p> <p>A*26 58%</p> <p>A*2601 34%</p> <p>A*260101 8%</p> <p>A*26 100% TOTAL</p> <p><u>50 labs</u></p> <p>B*35 38%</p> <p>B*3501 2%</p> <p>B*3503 2%</p> <p>B*3541 58%</p> <p>B*35 100% TOTAL</p> <p>B*38 40%</p> <p>B*3801 48%</p> <p>B*380101 10%</p> <p>B*38 98% TOTAL</p> <p><u>47 labs</u></p> <p>Cw*04 36%</p> <p>Cw*0401/09N 24%</p> <p>Cw*040101/09N 6%</p> <p>Cw*0401 28%</p> <p>Cw*040101 4%</p> <p>Cw*04010101 2%</p> <p>Cw*04 100% TOTAL</p> <p>Cw*12 26%</p> <p>Cw*1203 57%</p> <p>Cw*120301 13%</p> <p>Cw*12 96% TOTAL</p>	<p>Extract 391 <u>49 labs</u></p> <p>A*03 51%</p> <p>A*0301 41%</p> <p>A*030101 6%</p> <p>A*03010101 2%</p> <p>A*03 100% TOTAL</p> <p>A*68 31%</p> <p>A*6802/18N 8%</p> <p>A*6802 53%</p> <p>A*680201 6%</p> <p>A*6818N 2%</p> <p>A*68 100% TOTAL</p> <p><u>49 labs</u></p> <p>B*47 20%</p> <p>B*4702 80%</p> <p>B*47 100% TOTAL</p> <p>B*53 37%</p> <p>B*5301 47%</p> <p>B*530101 16%</p> <p>B*53 100% TOTAL</p> <p><u>46 labs</u></p> <p>Cw*04 39%</p> <p>Cw*0401/09N 24%</p> <p>Cw*040101/09N 7%</p> <p>Cw*0401 24%</p> <p>Cw*040101 4%</p> <p>Cw*0403 2%</p> <p>Cw*04 100% TOTAL</p> <p>Cw*06 35%</p> <p>Cw*0602 50%</p> <p>Cw*060201 11%</p> <p>Cw*06 96% TOTAL</p>	<p>Extract 392 (Japanese/Black) <u>49 labs</u></p> <p>A*24 61%</p> <p>A*2402 33%</p> <p>A*240201 2%</p> <p>A*24020101 4%</p> <p>A*24 100% TOTAL</p> <p>A*68 53%</p> <p>A*6802 39%</p> <p>A*680201 6%</p> <p>A*6818N 2%</p> <p>A*68 100% TOTAL</p> <p><u>49 labs</u></p> <p>B*47 25%</p> <p>B*4701 2%</p> <p>B*4702 4%</p> <p>B*4703 69%</p> <p>B*47 100% TOTAL</p> <p>B*52 33%</p> <p>B*5201/07 28%</p> <p>B*520101/07 8%</p> <p>B*5201 27%</p> <p>B*520101 4%</p> <p>B*52 100% TOTAL</p> <p><u>46 labs</u></p> <p>Cw*07 44%</p> <p>Cw*0701/06/18 16%</p> <p>Cw*0701/06 4%</p> <p>Cw*0701/18 4%</p> <p>Cw*0701 2%</p> <p>Cw*07020101 2%</p> <p>Cw*0718 28%</p> <p>Cw*07 100% TOTAL</p> <p>Cw*12 39%</p> <p>Cw*1202 59%</p> <p>Cw*12 98% TOTAL</p>
---	---	---	--

INVESTIGATOR	CELL NO.1301 (Caucasian)		B1	B2	C1	C2	method	
CTR	NAME	A1	A2					
745	Anthony Nola	*2405	*3001	*1302	*4402	*050101	*060201	SSO,SSP,RSCA+
2020	Barnardo,Mar	*2405	*3001	*130201	*4402/19N/27	*0501/03/04/08	*0602/09	SSP,SBT
5106	Brown,Colin	*2405	*3001/15	*1301/02/07N/08	*4402/11/19N/20+	*0501-06/08-10	*0602/06/07+	PCR-RVSSOP
5232	Charlton,Ron	*2405	*3001	*1302	*4402	*0501	*0602	SSP
4492	Charron,D.	*24	*30	*13	*44			
798	Claas,F.H.J.	*2405	*3001	*1302	*4402	*0501	*0602	SBT,RLB,SSP
3632	Colombe,Beth	*2405	*3001	*1302	*4402	*0501	*0602	SSP
16	Cook,Daniel	*2405	*300101	*130201	*440201/19N	*050101// *0504+	*060201// *0609+	PCR-RSSOP,SBT
5130	Costeas,Paul	*2405	*3001	*1302	*4402	*0501/06	*0602	SSP
779	Daniel,Claud	*24/*2466	*30	*13	*44	*05	*06	PCR-SSP
3625	Darke,Christ	*2405/14	*30	*13	*4402	*0501	*0602	PCR-SSP
4269	Dormoy,Anne	*2405	*300101	*130201	*44020101	*050101	*060201	PCR-SSP,SBT
3186	Dunckley,Hea	*2405	*30	*13	*44	*05	*06	SSP
3766	Dunn,Paul	*2405	*3001/14L/15	*1302/03	*4402+	*05	*06	SSO
856	Dupont,Bo	*2405	*3001/18/19	*13	*44	*0501/03/05/06+	*0602/07/10+	RVSSO
5214	Eckels/CPMC	*2405	*30	*13	*44	*05	*06	
4251	Ellis,Thomas	*2405	*3001	*1302	*4402/19N	*0501/03	*0602	PCR-SSO,SEQ
762	Fischer&Mayr	*2405	*3001	*1302	*4402/27	*0501/03	*0602	RSSO,SSP,SBT
729	Fotino,Maril	*2405	*3001	*1302	*4402	*0501/07N/08/10+	*0602	SSP
4985	Graff,Ralph	*24	*30	*13	*44	*05	*06	
810	Hamdi,Nuha	*2405	*300101	*130201	*44020101			SSO
3808	Hogan,Patric	*24	*30	*1301-03/06-08/11+	*44	*0501/03-08/12+	*0602/03/05+	
771	Israel,Shosh	*2405	*3001	*1302	*4402	*0501	*0602	SSP,SSO,SBT
859	Kamoun,Malek	*2405	*3001	*1302	*4402	*0501	*0602	PCR-SSP,SSO
4337	Kim,Tai-Gyu	*2405	*3001	*1302	*4402	*0501	*0602	SBT
168	Klein,Tirza	*2405	*3001	*1302	*4402	*0501	*0602	PCR-SSP
278	Lee,Jar-How	*2405	*3001/14L/15	*1302	*4402	*0501/07N/13	*0602/10/12/13	SSP,RVSSOP
759	Lefor,W.M.	*2405	*3001/15	*1302/03	*4402/11/21/27/33	*05	*06	RVSSO
731	Loewenthal,R	*2405	*300101	*130201	*440201/19N	*050101/03	*060201	SBT,SSO
8029	Mani,Rama	*24	*30	*13	*44			PCR-SSP
792	Moore,S.Brea	*24	*30	*13	*44	*05	*06	PCR-SSO
733	Mytilineos,J	*2405	*30	*13	*44	*05	*06	PCR-SSO
774	Paik,Young	*2405	*3001/15	*13	*44	*05	*06	SSP,SSOP
8001	Pancoska,Car	*24	*30	*13	*44	*05	*06	SSP,RVSSOP
4336	Park,Myoung	*2405	*3001/15	*1301/02/07N/08	*44	*05	*0602/07/09/10	RVSSO
4689	Rajczyk&Gyodi	*2405	*3001/15	*1302/03/08	*44	*05	*06	PCR-SSO,SSP
5200	Reinke,Dennis	*24	*30	*13	*44	*05	*06	SSP
1160	Rosen-Bronso	*2405	*30	*13	*44	*05	*06	RVSSO,SSP
793	Rubocki,Ron	*24	*30	*13	*44	*05	*06	PCR-SSP
4948	Sage,Deborah	NT						
4744	Satake,Masah	*2405	*300101	*130201	*440201			
3904	Stewart,Dod	*24	*30	*13	*44	*05	*06	PCR-SSP
769	Tavoularis,S	*2405	*3001	*1302	*4402/02S	*0501	*0602	SSO,SSP,SBT
747	Tiercy,Jean-	*2405	*3001	*130201	*4402	*050101	*060201	SSO,SSP,SBT
5462	Turner,E.V.	*2405	*3001	*1302	*4402	*0501	*0602	SSP
5451	Van den Berg-	*2405	*300101	*130201	*440201	*050101	*060201	SBT
5642	Varnavidou-N	*24	*30	*13	*44	*05	*06	PCR-SSP,SSO
705	Watkins,Davi	*2402g	*3001g	*1301g	*4402g	*0501g	*0602g	PCR-SSP
1466	Yu_Neng/ARC	*2405	*3001	*130201	*4402/19N/27	*0501/03	*0602	PCR-SSOP,SBT

INVESTIGATOR	CELL NO.1302 (Hispanic)		B1	B2	C1	C2	method
CTR NAME	A1	A2					
745 Anthony Nola	*0201	*2902	*440301	*511301	*1502	*160101	SSO,SSP,RSCA+
2020 Barnardo,Mar	*0201/09/43N/66+	*290201	*440301	*511301	*1502/03	*160101	SSP,SBT
5106 Brown,Colin	*02	*29	*44	*5113	*1502/07/11/13+	*1601/02	PCR-RVSSOP
5232 Charlton,Ron	*0201	*2902	*4403	*5113	*1502	*1601	SSP
4492 Charron,D.	*02	*29	*44	*51			
798 Claas,F.H.J.	*0201	*2902	*4403	*5113	*1502	*1601	SBT,RLB,SSP
3632 Colombe,Beth	*0201	*2902	*4403	*5113	*1502	*1601	SSP
16 Cook,Daniel	*020101	*290201	*440301	*511301	*150201//*1507	*160101//*1602	PCR-RSSOP,SBT
5130 Costeas,Paul	*0201	*2902	*4403	*5113	*1514	*1601	SSP
779 Daniel,Claud	*02	*29	*44	*51	*15	*16	PCR-SSP
3625 Darke,Christ	*02	*29	*4403	*5113	*1502/14	*1601	PCR-SSP
4269 Dormoy,Anne	*020101	*290201	*440301	*511301	*150201	*160101	PCR-SSP,SBT
3186 Dunckley,Hea	*02	*29	*44	*51	*15	*07	SSP
3766 Dunn,Paul	*02	*29	*4403+	*5113	*15	*16	SSO
856 Dupont,Bo	*02	*2901/02/04/06+	*4403/07/13/26/30+	*5113	*1502/07/11/13+	*1601/02/08	RVSSO
5214 Eckels/CPMC	*02	*29	*44	*5113	*15	*16	
4251 Ellis,Thomas	*0201	*2902	*4403	*5113	*1502/03	*1601	PCR-SSO,SEQ
762 Fischer&Mayr	*0201/09	*2902	*4403	*5113	*1502/07/10	*1601/02	RSSO,SSP,SBT
729 Fotino,Maril	*0201	*2902	*4403	*5113	*1502	*1602	SSP
4985 Graff,Ralph	*02	*29	*44	*51	*15	*16	
810 Hamdi,Nuha	*0225	*29010101	*440301	*511301			SSO
3808 Hogan,Patric	*02	*2901-12/15	*44		*1502/03/05/10+	*1601/06-08	
771 Israel,Shosh	*0201	*2902	*4403	*5113	*1502	*1601	SSP,SSO,SBT
859 Kamoun,Malek	*0201	*2902	*4403	*5113	*1502	*1601	PCR-SSP,SSO
4337 Kim,Tai-Gyu	*0201	*2902	*4403	*5113	*1502	*1601	SBT
168 Klein,Tirza	*0201	*2902	*4403	*5113	*1502	*1601	PCR-SSP
278 Lee,Jar-How	*0201/0102L/66+	*2902/10/11	*4403/36/38/39	*5113	*1502	*1601	SSP,RVSSOP
759 Lefor,W.M.	*0201/07/09/18+	*2901/02/04/06+	*4403/26/35/36/38+	*5113	*15	*16	RVSSO
731 Loewenthal,R	*020101	*290201	*440301	*511301	*150201/13	*160101	SBT,SSO
8029 Mani,Rama	*02	*29	*44	*51			PCR-SSP
792 Moore,S.Brea	*02	*29	*44	*51	*15	*16	PCR-SSO
733 Mytilineos,J	*02	*29	*44	*5113	*15	*16	PCR-SSO
774 Paik,Young	*02	*29	*44	*5113	*15	*16	SSP,SSOP
8001 Pancoska,Car	*02	*29	*44	*51	*15	*16	SSP,RVSSOP
4336 Park,Myoung	*02	*29	*44	*5113	*15	*1601/02	RVSSO
4689 Rajczy&Gyodi	*02	*29	*44	*5113	*15	*1601/02/08	PCR-SSO,SSP
5200 Reinke,Dennis	*02	*29	*44	*51	*15	*16	SSP
1160 Rosen-Bronso	*02	*29	*44	*51	*15	*16	RVSSO,SSP
793 Rubocki,Ron	*02	*29	*44	*51	*15		PCR-SSP
4948 Sage,Deborah	NT						
4744 Satake,Masah	*020101	*290201	*440301	*511301			
3904 Stewart,Dod	*02	*29	*44	*511301	*15	*16	PCR-SSP
769 Tavoularis,S	*0201/01L	*2902	*4403/38	*5113	*1502/13	*1601	SSO,SSP,SBT
747 Tiercy,Jean-	*0201	*290201	*4403	*5113	*150201	*160101	SSO,SSP,SBT
5462 Turner,E.V.	*0201	*2902	*4403	*5113	*1502	*1601	SSP
5451 Van den Berg-	*020101	*290201	*440301	*511301	*150201	*160101	SBT
5642 Varnavidou-N	*02	*29	*44	*51	*15	*16	PCR-SSP,SSO
705 Watkins,Davi	*0201g	*2901g	*4402g	*511301/1302/19	*1502g	*1601g	PCR-SSP
1466 Yu_Neng/ARC	*0201/09/43N/66+	*290201	*440301	*511301	*150201/13	*160101	PCR-SSOP,SBT

INVESTIGATOR	CELL NO.1303 (Chinese)							
CTR	NAME	A1	A2	B1	B2	C1	C2	method
745	Anthony Nola	*0207	*24020102L	*080101	*460101	*0102	*070201	SSO,SSP,RSCA+
2020	Barnardo,Mar	*0207	*2402/40N	*0801/19N	*4601	*0102	*070201	SSP,SBT
5106	Brown,Colin	*02	*24	*08	*4601/02	*0102/05-08/11	*07	PCR-RVSSOP
5232	Charlton,Ron	*0207	*2402	*0801	*4601	*0102	*0702	SSP
4492	Charron,D.	*0207	*24020102L	*0801/29/30	*4601	*0102	*0702/42	PCR-SSP
798	Claas,F.H.J.	*0207	*24020102L	*0801	*4601	*0102	*0702	SBT,RLB,SSP
3632	Colombe,Beth	*0207	*2402	*0801	*4601	*0102	*0702	SSP
16	Cook,Daniel	*0207/15N	*24020102L	*080101	*460101	*010201//*0117	*070201//*0739	PCR-RSSOP,SBT
5130	Costeas,Paul	*0207	*24020102L	*0801	*4601	*0102	*0702	SSP
779	Daniel,Claud	*02	*24	*08	*46	*01	*07	PCR-SSP
3625	Darke,Christ	*0207/15N/18	*2402102L	*08	*46	*0102/05	*0702/10	PCR-SSP
4269	Dormoy,Anne	NT						PCR-SSP,SBT
3186	Dunckley,Hea	*02	*24	*08	*46	*01	*07	SSP
3766	Dunn,Paul	*02	*2402L	*08	*4601/02	*01	*0702/32N	SSO
856	Dupont,Bo	*0207/15N/18	*24	*08	*4601	*0102/05-08/11	*0701-03/05+	RVSSO
5214	Eckels/CPMC	*02	*2402L	*08	*46	*01	*07	
4251	Ellis,Thomas	*0207	*2402	*0801	*4601	*0102	*0702	PCR-SSO,SEQ
762	Fischer&Mayr	*0207	*2402	*0801	*4601	*0102	*0702	RSSO,SSP,SBT
729	Fotino,Maril	*0207	*24020102L	*0801	*4601	*0102	*0702	SSP
4985	Graff,Ralph	*02	*24	*08	*46	*01	*07	
810	Hamdi,Nuha	*0236	*24020102L	*080101	*4601			SSO
3808	Hogan,Patric	*02	*24	*08	*4601-03/05/07N-10	*0102/03/06-11+	*0702/03/10+	
771	Israel,Shosh	*0207	*24020102L	*0801	*4601	*0102	*0702	SSP,SSO,SBT
859	Kamoun,Malek	*0207	*2402/020102L	*0801	*4601	*0102	*0702	PCR-SSP,SSO
4337	Kim,Tai-Gyu	*0207/15N	*2402/09N	*0801	*4601	*0102	*0702	SBT
168	Klein,Tirza	*0207	*2402	*0801	*4601/03/05/07N/08	*0102	*0702	PCR-SSP
278	Lee,Jar-How	*0207	*24020102L	*0801/15/22/24/30N	*4601	*0102/11	*0702/32N/39	SSP,RVSSOP
759	Lefor,W.M.	*0201/07/09/18+	*2402L	*0801/15/18/22/24+	*4601/02	*01	*07	RVSSO
731	Loewenthal,R	*0207	*240201	*080101	*460101	*010201/02	*070201	SBT,SSO
8029	Mani,Rama	*02	*24	*08	*46			PCR-SSP
792	Moore,S.Brea	*02	*24	*08	*46	*01	*07	PCR-SSO
733	Mytilineos,J	*02	*2402L	*08	*46	*01	*07	PCR-SSO
774	Paik,Young	*02	*24020102L	*08	*46	*01	*07	SSP,SSOP
8001	Pancoska,Car	*02	*24	*08	*46	*01	*17	SSP,RVSSOP
4336	Park,Myoung	*02	*24	*08	*4601/02	*01	*07	RVSSO
4689	Rajczyk&Gyodi	*02	*24020102L	*0801/18/24/27	*4601/02	*01	*07	PCR-SSO,SSP
5200	Reinke,Dennis	*02	*24	*08	*46	*01	*07	SSP
1160	Rosen-Bronso	*02	*2402102L	*08	*46	*01	*07	RVSSO,SSP
793	Rubocki,Ron	*02	*24	*08	*46	*01	*07	PCR-SSP
4948	Sage,Deborah	NT						
4744	Satake,Masah	*0207	*24020102L	*080101	*4601			
3904	Stewart,Dod	*02	*24	*08	*46	*01	*07	PCR-SSP
769	Tavoularis,S	*0207	*2402L	*0801	*4601	*0102	*0702	SSO,SSP,SBT
747	Tiercy,Jean-	NT						
5462	Turner,E.V.	*0207	*2402	*0801	*4601	*0102	*0702	SSP
5451	Van den Berg-	*0207	*24020102L	*080101	*460101	*0102	*070201	SBT
5642	Varnavidou-N	*02	*24	*08	*46	*01	*07	PCR-SSP,SSO
705	Watkins,Davi	*0201g	*2402g	*0801g	*4601g		*0702g	PCR-SSP
1466	Yu_Neng/ARC	*0207/15N	*2402/02L/09N+	*080101/19N	*460101	*0102	*0702	PCR-SSOP,SBT

INVESTIGATOR	CELL NO.1304 (Filipino)		B1	B2	C1	C2	method
CTR NAME	A1	A2					
745 Anthony Nola	*0101	*3401	*570101	*1521	*0403	*060201	SSO,SSP,RSCA+
2020 Barnardo,Mar	*0101/04N	*3401	*570101	*1521	*0403	*0602	SSP,SBT
5106 Brown,Colin	*0101/04N/09/11N+	*3401/05	*5701/06	*1521	*0403	*0602/07/10	PCR-RVSSOP
5232 Charlton,Ron	*0101	*3401	*5701	*1521	*0403	*0602/03	SSP
4492 Charron,D.	*0101	*3401	*5701	*1521	*0403	*0602	PCR-SSP
798 Claas,F.H.J.	*0101	*3401	*5701	*1521	*0403	*0602	SBT,RLB,SSP
3632 Colombe,Beth	*0101	*3401	*5701	*1521	*0403	*0602	SSP
16 Cook,Daniel	*010101/04N/22N	*3401	*570101	*1521	*0403	*060201	PCR-RSSOP,SBT
5130 Costeas,Paul	*0101	*3401	*5701	*1521	*0403	*0602	SSP
779 Daniel,Claud	*01	*34	*57	*15(B75)	*04	*06	PCR-SSP
3625 Darke,Christ	*01	*34	*57	*1521	*0403	*0602	PCR-SSP
4269 Dormoy,Anne	NT						
3186 Dunckley,Hea	*01	*34	*57	*1502/21/44	*04	*06	SSP
3766 Dunn,Paul	*01	*3401/05	*5701/06	*1521	*0403	*06	SSO
856 Dupont,Bo	*0101/04N/09/11N+	*3401/05	*5701/06	*1521	*0403	*0602/07/10+	RVSSO
5214 Eckels/CPMC	*01	*34	*57	*1521	*04	*06	
4251 Ellis,Thomas	*0101	*3401	*5701	*1521	*0403	*0602	PCR-SSO,SEQ
762 Fischer&Mayr	*0101	*3401	*5701	*1521	*0403	*0602	RSSO,SSP,SBT
729 Fotino,Maril	*0101	*3401	*5701	*1521	*0403/16	*0602	SSP
4985 Graff,Ralph	*01	*34	*57	*15	*04	*06	
810 Hamdi,Nuha	*01010101	*3401	*570101	*1521			SSO
3808 Hogan,Patric	*01	*3401-06/08	*5701-04/06/07/09+	*1521/44	*0401/03/05/07+	*0602/03/07+	
771 Israel,Shosh	*0101	*3401	*5701	*1521	*0403	*0602	SSP,SSO,SBT
859 Kamoun,Malek	*0101	*3401	*5701	*1521	*0403	*0602	PCR-SSP,SSO
4337 Kim,Tai-Gyu	*0101	*3401	*5701	*1521	*0403	*0602	SBT
168 Klein,Tirza	*0101	*3401	*5701	*1502	*0403	*0602/03	PCR-SSP
278 Lee,Jar-How	*0101/0102N/11N+	*3401/05	*5701	*1521	*0403	*0602/10/12/13	SSP,RVSSOP
759 Lefor,W.M.	*0101/09	*3401/05	*5701/06	*1521	*0403	*06	RVSSO
731 Loewenthal,R	*010101	*3401	*570101	*1521	*0403	*060201	SBT,SSO
8029 Mani,Rama	*01	*34	*59	*15			PCR-SSP
792 Moore,S.Brea	*36	*34	*57	*15(B75)	*04	*06	PCR-SSO
733 Mytilineos,J	*01	*34	*57	*1521	*0403	*06	PCR-SSO
774 Paik,Young	*01	*34	*5701/08	*1521/44	*0403/06	*06	SSP,SSOP
8001 Pancoska,Car	*01	*34	*57	*1521	*04	*06	SSP,RVSSOP
4336 Park,Myoung	*0101/04N/09/11N	*3401/05	*5701/06	*1521	*0403	*0602/07/10	RVSSO
4689 Rajczy&Gyodi	*0101/09	*3401/05	*5701/06	*1521	*04	*06	PCR-SSO,SSP
5200 Reinke,Dennis	*01	*34	*57	*15(B75)	*04	*06	SSP
1160 Rosen-Bronso	*01	*34	*57	*1521	*04	*06	RVSSO,SSP
793 Rubocki,Ron	*01	*34	*57	*15(B75)	*04	*06	PCR-SSP
4948 Sage,Deborah	NT						
4744 Satake,Masah	*010101	*3401	*570101	*1521			
3904 Stewart,Dod	*01	*34	*57	*1521	*04	*06	PCR-SSP
769 Tavoularis,S	*0101/01N	*3401	*5701	*1521	*0403	*0602	SSO,SSP,SBT
747 Tiercy,Jean-	NT						
5462 Turner,E.V.	*0101	*3401	*5701	*1521	*0403	*0602/03	SSP
5451 Van den Berg-	*010101	*3401	*570101	*1521	*0403	*060201	SBT
5642 Varnavidou-N	*01	*34	*57	*15	*04	*06	PCR-SSP,SSO
705 Watkins,Davi	*0101g	*3401g	*5701-04/06/07/09+	*1502/21/44/88/95+	*0401g	*06	PCR-SSP
1466 Yu_Neng/ARC	*0101/04N/16N	*3401	*570101	*1521	*0403	*060201	PCR-SSOP,SBT

Cell 1301 (Caucasian)	Cell 1302 (Hispanic)	Cell 1303 (Chinese)	Cell 1304 (Filipino)
<u>48 labs</u>	<u>48 labs</u>	<u>46 labs</u>	<u>46 labs</u>
A*24 27%	A*02 58%	A*02 57%	A*01 56%
A*2405 73%	A*0201 29%	A*0207 41%	A*0101 33%
A*24 100% TOTAL	A*020101 11%	A*0236 2%	A*010101 7%
	A*0225 2%	A*02 100% TOTAL	A*01010101 2%
A*30 42%	A*02 100% TOTAL		A*01 98% TOTAL
A*3001/15 10%		A*24 39%	
A*3001 35%	A*29 52%	A*2402 15%	A*34 37%
A*300101 13%	A*29010101 2%	A*240201 2%	A*3401/05 15%
A*30 100% TOTAL	A*2902 29%	A*2402L 11%	A*3401 48%
	A*290201 17%	A*2402102L 5%	A*34 100% TOTAL
	A*29 100% TOTAL	A*24020102L 28%	
		A*24 100% TOTAL	
<u>48 labs</u>	<u>48 labs</u>	<u>46 labs</u>	<u>46 labs</u>
B*13 50%	B*44 52%	B*08 59%	B*57 35%
B*1302 31%	B*4403 29%	B*0801 28%	B*5701/06 13%
B*130201 19%	B*440301 19%	B*080101 13%	B*5701 33%
B*13 100% TOTAL	B*44 100% TOTAL	B*08 100% TOTAL	B*570101 17%
			B*57 98% TOTAL
B*44 61%	B*51 25%	B*46 39%	
B*4402 31%	B*5113 52%	B*4601/02 11%	B*15 24%
B*440201 4%	B*511301 21%	B*4601 39%	B*1502 2%
B*44020101 4%	B*51 98% TOTAL	B*460101 11%	B*1521 74%
B*44 100% TOTAL		B*46 100% TOTAL	B*15 100% TOTAL
<u>44 labs</u>	<u>44 labs</u>	<u>43 labs</u>	<u>43 labs</u>
Cw*05 68%	Cw*15 66%	Cw*01 56%	Cw*04 37%
Cw*0501 23%	Cw*1502 25%	Cw*0102 42%	Cw*0403 63%
Cw*050101 9%	Cw*150201 7%	Cw*01 98% TOTAL	Cw*04 100% TOTAL
Cw*05 100% TOTAL	Cw*1514 2%		
	Cw*15 100% TOTAL	Cw*07 56%	Cw*06 58%
Cw*06 55%		Cw*0702 33%	Cw*0602 30%
Cw*0602 34%	Cw*16 47%	Cw*070201 9%	Cw*060201 12%
Cw*060201 11%	Cw*1601 30%	Cw*07 98% TOTAL	Cw*06 100% TOTAL
Cw*06 100% TOTAL	Cw*160101 16%		
	Cw*1602 2%		
	Cw*16 95% TOTAL		

INTERNATIONAL CELL EXCHANGE

		***** CELL NO.1301 *****						***** CELL NO.1302 *****				***** CELL NO.1303 *****						***** CELL NO.1304 *****														
		V						V				V						V														
		I						I				I						I														
		(CAUC)						(HISP)				(CHIN)						(FILP)														
INVESTIGATOR	DAYS	A	A	B	B	C	C	B	A	A	B	B	B	A	A	B	B	C	C	B	A	A	B	B	C	C	B	B				
NAME	OLD	%	9	3	1	4	W	W	W	%	2	2	4	5	W	%	4	2	8	4	W	W	W	%	1	3	5	7	X	W	W	W
			0	3	4	5	6	4	OTHERS		9	4	1	4	OTHERS		4	6	1	7	6	OTHERS		4	7	5	4	6	4	6	OTHERS	
Abbal, M. Pro	6	100	+	+	+	+				100	+	+	+	+							100	+	+	+	+							
Alonso, Anton	7	90	23	+	+	+	+	+	+	90	+	+	+	+	+						90	+	+	+	+	+						
Alvarez, Carr	6	100	+	+	+	+				100	+	+	+	+	+						100	+	+	+	+							
Anthony Nola	3	99	23	+	+	+				99	+	+	+	+							99	+	+	+	+							
Berka, Noured	2	90	23	+	+	+	+	+	+	90	+	+	+	+	+						90	+	+	+	+	+						
Bow, Laurine	6	99	23	+	+	+				98	+	+	+	+	+						98	+	+	+	+							
Burger, Joe	3	99	24	+	+	+	+	+	+	99	+	+	+	+	+						99	+	+	+	+	+						
Chan MD, Soh	4	95	23	+	+	+	+	+	+	95	+	+	+	+	+						95	+	+	+	+	+						
Charoenwongs	6	88	23	+	+	+				88	+	+	+	+	+						82	+	+	+	+							
Charron, D. P	6	95	+	+	+	+				95	+	+	+	+	+						100	+	+	+	+							
Chongkolwata	6	99	23	+	+	+				99	+	+	+	+	+						99	+	+	+	+							
Choo, Yoon MD	2	99	23	+	+	+	+	+	+	99	+	+	+	+	+						99	+	+	+	+	+						
Ciccio/Willi	7	99	+	+	+	+	+	+	+	99	+	+	+	+	+						99	+	+	+	+	+						
Claas, F.H.J.	3	90	24	+	+	+	+	+	+	90	+	+	+	+	+						90	+	+	+	+	+						
Cook, Daniel	2	95	23	+	+	+	+	+	+	95	+	+	+	+	+						95	+	+	+	+	+						
Daniel, Dolly	6	99	+	+	+	+				98	+	+	+	+	+						98	+	+	+	+							
Danilovs, Joh	2	98	23	+	+	+	+	+	+	98	+	+	+	+	+						98	+	+	+	+	+						
Darke, Christ	6	90	+	+	+	+	+	+	+	90	+	+	+	+	+						90	+	+	+	+	+						
Du Toit, Erne	14	80	23	+	+	+				70	+	+	+	+	+						80	+	+	+	+							
Dunckley, Hea	9	99	2419	+						99	+	+	+	+	+						99	+	+	+	+							
Dunk, Arthur	2	98	23	+	+	+	+	+	+	98	+	+	+	+	+						98	+	+	+	+	+						
Dunn, Paul Ph	7	95	23	+	+	+				95	+	+	+	+	+						95	+	+	+	+							
Eckels/CPMC,	2	99	24	+	+	+	+	+	+	99	+	+	+	+	+						99	+	+	+	+	+						
Eckels/Utah,	3	98	23	+	+	+	+	+	+	99	+	+	+	+	+						99	+	+	+	+	+						
Fotino, Maril	2	90	23	+	+	+	+	+	+	90	+	+	+	+	+						90	+	+	+	+	+						
Foxcroft, Z.K	6	90	23	+	+	+				90	+	+	+	+	+						90	+	+	+	+							
Furukawa, Yok	6	93	+	+	+	+	+	+	+	96	+	+	+	+	+						94	+	+	+	+	+						
Goggins, R.	2	98	23	+	+	+	+	+	+	98	+	+	+	+	+						98	+	+	+	+	+						
Hahn, Amy B.	3	99	23	+	+	+				99	+	+	+	+	+						99	+	+	+	+	+						
Hajeer, Ali D	12	???	23	+	+					???	+	+	+	+	+						???	+	+	+	+							
Harville/ACH	2	98	23	+	+	+	+	+	+	98	+	+	+	+	+						98	+	+	+	+	+						
Harville/UA,	3	95	23	+	+	+	+	+	+	95	+	+	+	+	+						95	+	+	+	+	+						
Henrico Doct	6	99	23	+	+	+				99	+	+	+	+	+						95	+	+	+	+							
Holdsworth, R	8	90	+	+	+	+				98	+	+	+	+	+						95	+	+	+	+	+						
Ichikawa MD,	8	???	24	+	+	+	+	+	+	???	+	+	+	+	+						???	+	+	+	+	+						
Israel, Shosh	8	95	+	+	+	+	+	+	+	95	+	+	+	+	+						95	+	+	+	+	+						
Keown, Paul M	3	98	23	+	+	+				98	+	+	+	+	+						98	+	+	+	+							
Kim, Kyeong-H	6	95	+	+	+	+				95	+	+	+	+	+						95	+	+	+	+	+						
Klein, Jon MD	2	95	23	+	+	+				95	+	+	+	+	+						95	+	+	+	+	+						
Klein, Tirza	6	98	23	+	+	+	+	+	+	98	+	+	+	+	+						98	+	+	+	+	+						
Kohara, Setsu	9	98	23	+	+	+				98	+	+	+	+	+						98	+	+	+	+	+						
Kopko, Patric	3	96	23	+	+	+	+	+	+	97	+	+	+	+	+						98	+	+	+	+	+						
Kvam, Vonnett	3	95	23	+	+	+	+	+	+	96	+	+	+	+	+						96	+	+	+	+	+						
Lardy, N.M. D	8	100	23	+	+	+				100	+	+	+	+	+						100	+	+	+	+	+						
Lazda, Velta	2	98	23	+	+	+	+	+	+	98	+	+	+	+	+						98	+	+	+	+	+						
Lebeck, Laura	2	98	23	+	+	+	+	+	+	98	+	+	+	+	+						98	+	+	+	+	+						
Leech MD, Ste	5	99	23	+	+	+	+	+	+	99	+	+	+	+	+						99	+	+	+	+	+						
Lefor, W.M. P	2	99	24	+	+	+	+	+	+	99	+	+	+	+	+						99	+	+	+	+	+						
Lo, Raymundo	7	98	23	+	+	+				98	+	+	+	+	+						98	+	+	+	+	+						
Loewenthal M	5	95	24	+	+	+	+	+	+	95	+	+	+	+	+						95	+	+	+	+	+						

INTERNATIONAL CELL EXCHANGE

***** CELL NO.1301 *****										***** CELL NO.1302 *****										***** CELL NO.1303 *****										***** CELL NO.1304 *****									
V										V										V										V									
I										I										I										I									
(CAUC)										(HISP)										(CHIN)										(FILP)									
INVESTIGATOR	A	A	A	B	B	C	C	B		A	A	A	B	B	B			A	A	A	B	B	C	C	B	B		A	A	A	B	B	C	C	B	B			
DAYS	B	9	3	1	4	W	W	W		B	2	2	4	5	W			B	2	2	8	4	W	W	W		B	1	3	5	7	X	W	W	W				
NAME	OLD	%	0	3	4	5	6	4	OTHERS	%	9	4	1	4	OTHERS			%	4	6	1	7	6	OTHERS			%	4	7	5	4	6	4	6	OTHERS				
MacCann, Eile	3	98	23	+	+			+	A31	98	+	+	+	+	+			98	+	+	+				98	+	+	+15		+	+								
Mah, Helen	3	99	24	+	+	+	+	+	A24V	99	+	+	+	+	+			99	+	+	+	+	+	+		99	+	+	+W4		+	+							
McAlack, Robe	2	98	23	+	+	+	+	+		97	+	+	+	+		CX15		97	+	+	+	+	+	+		98	+	+	+	+	+	+							
McAlack-Bala	2	99	23	+	+	+	+	+		99	+	+	+	+				95	+	+	+	+	+	+		99	+	+	+	+	+	+							
McCluskey, Ja	9	95	23	+	+	+	+	+		90	+	+	+	+				90	+	+	+	+	+	+		95	+	+17	+03		+	+							
Murad, Shahna	14	90		+	+	+		+	A2	97		+	+	+		A28, A33		98	+	+	+	+	+	+		98	+	+	+W4		+	+							
Noche, Olivia	4	99	23	+	+	+	+	+		99	+	+	+	+				99	+	+	+	+	+	+		99	+	+	+	+	+	+							
Norin, Allen	2	99	23	+	+	+		+		99	+	+	+	+				99	+	+	+		+			99	+	+	+	+	+	B63, B58							
Paik, Young K	2	95	23	+	+	+	+	+		95	+	+	+	+				95	+	+	+	+	+	+		95	+	+	+W4		+	+							
Pais, Maria L	**	98	23	+	+	+				98	+	+	+	+				98	+	+	+					98	+	+	+15										
Park, Myoung	8	98	24	+	+	+		+		97	+	+	+	+				93	+	+	+	+	+	+		95	+	+	+	+	+	+							
Phelan, Donna	3	98	23	+	+	+	+	+		98	+	+	+	+		CX16, CX15		98	+24	+	+	+	+	+		98	+	+		+	+	B62, B58							
Pollack, Mari	2	99	23	+	+	+	+	+		99	+	+	+	+				99	+	+	+	+	+	+		99	+	+	+	+	+	+							
Rajczyk, Gyodi	3	95	23	+	+	+	+	+		95	+	+	+B5	+				95	+	+	+	+	+	+		95	+	+1715		+	+								
Rosen-Bronso	2	90	23	+	+	+		+	A24	90	+	+	+	+				90	+	+						90	+	+				B58							
Rosenberg, J.	3	98	23	+	+	+	+	+		98	+	+	+	+		CX16, CX15		98	+	+	+	+	+	+		98	+	+	+W4		+	+							
Rubocki, Rona	2	96		+	+	+	+	+		98	+	+	+	+				98	+	+	+	+	+	+		98	+	+	+W4		+	+							
Satake, Masah	3	100	23	+	+	+	+	+	A23V	100	+	+	+	+				100	+	+	+	+	+	+		100	+	17	+		+	A26							
Sauer, Norber	3	100	23	+	+	+	+	+		100	+	+	+	+				100	+	+	+	+	+	+		100	+	+	+	+	+	+							
Semana MD, Gi	10	90	23	+	+	+		+		90	+	+	+	+				90	+	+	+		+			90	+10	+	+	+	+	+							
Smith/Baylor	10	99	23	+	+	+		+		90	+	+	+	+				99	+	+	+		+			99	+	+	+	+	+	+							
Stamm, Luz	2	98	23	+	+	+	+	+	BW6	98	+	+	+	+				98	+	+	+	+	+	+		98	+	+	+	+	+	+							
Steinberg, Ka	2	96		+	+	+	+	+	A9V	96	+	+	+	+				96	+	+	+	+	+	+		96	+	+	+W4		+	+	3401, B75V						
Stewart, Dod	2	99	24	+	+	+	+	+		99	+	+	+	+				99	+24	+	+	+	+	+		99	+	+	+15W4		+	+	B15V						
Tagliere, Jac	2	100		+	+	+	+	+		100	+	+	+	+				100	+	+	+	+	+	+		100	+	+	+	+	+	+							
Tbakhi, Abdel	11	96	23	+	+	+	+	+		95	+	+	+	+				95	+	+	+	+	+	+		96	+	+	+W4		+	+							
Tiercy, Jean-	7	95	23	+	+	+		+		95	+	+	+	+			NT		NT							NT													
Van Den Berg	6	???		+	+	+		+		???	+	+	+	+			???	+	+	+		+				???	+	+	+	+	+	+							
Varnavidou-N	6	98		+	+	+		+		98	+	+	+	+				98	+	+	+		+			98	+	+	+	+	+	+							
Vidan-Jeras,	6	100	23	+	+	+	+	+		100	+	+	+	+				100	+	+	+	+	+	+		100	+	+	+	+	+	+							
Walter Reed	2	98	23	+	+	+	+	+		98	+	+	+	+		CW5		98	+	+	+	+	+	+		98	+	+	+	+	+	+	B62						
Ward, William	2	98	23	+	+	+	+	+		98	+	+	+	+				98	+	+	+	+	+	+		98	+	+	+	+	+	+	B58						
Watkins, Davi	7	90	23	+	+	+	+	+		90	+	+	+	+		CW5		85	+	+	+	+	+	+		90	+	+	+	+	+	+							
Wernet, Peter	6	98	24	+	+	+		+		98	+	+	+	+				98	+	+	+		+			98	+	+	+	+	+	+							
Williams, Mar	6	98	23	+	+	+	+	+		99	+	+	+	+				97	+	+	+	+	+	+		90	+	+	+	+	+	+							
Wisecarver, J	6	90	24	+	+	+		+		85	+	+	+	+				95	+24	+	+		+			88	+	+	+	+	+	+							

 * *
 * SUMMARY TABLE *
 * *

(CAUC)
 **** CELL 1301 ****
 (86 SAMPLES TYPED)
 A9 17.4%
 A23 67.4%
 A24 14.0%
 (98.8%)
 A30 96.5%
 A19 1.2%
 (97.7%)
 B13 100.0%
 B44 100.0%
 (100.0%)
 CW5 62.8%
 CW6 62.8%
 BW4 94.2%

(HISP)
 **** CELL 1302 ****
 (86 SAMPLES TYPED)
 A2 98.8%
 (98.8%)
 A29 98.8%
 (98.8%)
 B44 100.0%
 (100.0%)
 B51 97.7%
 B5 1.2%
 (98.8%)
 BW4 95.3%

(CHIN)
 **** CELL 1303 ****
 (85 SAMPLES TYPED)
 A2 100.0%
 (100.0%)
 A24L 0.0%
 A24 4.7%
 (4.7%)
 B8 100.0%
 B46 96.5%
 CW1 67.1%
 CW7 67.1%
 BW6 95.3%

(FILP)
 **** CELL 1304 ****
 (84 SAMPLES TYPED)
 A1 100.0%
 A34 96.4%
 A10 1.2%
 (97.6%)
 B57 86.9%
 B17 6.0%
 (92.9%)
 B75 84.5%
 B15 7.1%
 (91.7%)
 CX4 0.0%
 CW4 21.4%
 C403 2.4%
 C4X6 1.2%
 (25.0%)
 CW6 63.1%
 BW4 92.9%
 BW6 92.9%

(OTHERS FOUND)
 A23V 2.3%
 A31 2.3%
 A9V 1.2%
 A2 1.2%
 B47 1.2%
 CW4 1.2%
 A24 1.2%
 2405 1.2%
 BW6 1.2%
 A24V 1.2%

(OTHERS FOUND)
 CX15 7.0%
 CX16 2.3%
 CW7 2.3%
 CW5 2.3%
 A33 1.2%
 A28 1.2%
 CW2 1.2%
 CW4 1.2%
 CW6 1.2%

(OTHERS FOUND)
 CW2 1.2%
 A32 1.2%
 A26 1.2%

(OTHERS FOUND)
 B62 8.3%
 B58 7.1%
 3401 4.8%
 CW7 2.4%
 B75V 1.2%
 A26 1.2%
 A43 1.2%
 B15V 1.2%
 CW3 1.2%
 B63 1.2%